

SHARP®

DVD RECORDER MODEL

DV-RW2U

OPERATION MANUAL

RW
COMPATIBLE



SPATIALIZER®
N-2-2™



• The region number
for this recorder is 1



! IMPORTANT / IMPORTANTE

EZ SET UP (AUTO CHANNEL /CLOCK SET UP)

EZ SET UP (PROGRAMACIÓN AUTOMÁTICA DE CANAL/PUESTA EN HORA DEL RELOJ)

1 Connect Antenna/Cable to recorder first.

En primer lugar conecte la antena/el cable a el producto.

2 Then, plug into AC Power Outlet.

A continuación, enchúfelos al tomacorriente de CA.

3 Do not press the **POWER** button until completion of EZ Set Up.

*No pulse el botón de **ALIMENTACIÓN (POWER)** hasta haber terminado la EZ SET UP.*

4 EZ SET UP complete.
EZ SET UP completo.

- Please read this Operation Manual carefully before using your recorder.
- Instrucciones importantes de seguridad y guía de operación rápida en español →Página 105

Detail: Please see page 23
Detalle: véase la página 23



For future reference, record the model and serial number (located on the rear of the product) in the space provided.

Model No.: DV-RW2U

Serial No.: _____

WARNING: TO REDUCE THE RISK OF FIRE OR ELECTRIC SHOCK, DO NOT EXPOSE THIS APPLIANCE TO RAIN OR MOISTURE.

 <div data-bbox="347 555 630 654" style="border: 1px solid black; padding: 5px; text-align: center;"> CAUTION RISK OF ELECTRIC SHOCK DO NOT OPEN </div>  <p>CAUTION: TO REDUCE THE RISK OF ELECTRIC SHOCK, DO NOT REMOVE COVER. NO USER-SERVICEABLE PARTS INSIDE. REFER SERVICING TO QUALIFIED SERVICE PERSONNEL.</p>	 <p>This symbol warns the user of uninsulated voltage within the unit that can cause dangerous electric shocks.</p>  <p>This symbol alerts the user that there are important operating and maintenance instructions in the literature accompanying this unit.</p>
--	---

“WARNING—FCC Regulations state that any unauthorized changes or modifications to this equipment not expressly approved by the manufacturer could void the user’s authority to operate this equipment.”

INFORMATION

This equipment has been tested and found to comply with the limits for a Class B digital device, pursuant to Part 15 of the FCC Rules. These limits are designed to provide reasonable protection against harmful interference in a residential installation. This equipment generates, uses and can radiate radio frequency energy and, if not installed and used in accordance with the instructions, may cause harmful interference to radio communications. However, there is no guarantee that interference will not occur in a particular installation. If this equipment does cause harmful interference to radio or television reception, which can be determined by turning the equipment off and on, the user is encouraged to try to correct the interference by one or more of the following measures:

- Reorient or relocate the receiving antenna.
- Increase the separation between the equipment and receiver.
- Connect the equipment into an outlet on a circuit different from that to which the receiver is connected.
- Consult the dealer or an experienced radio/TV technician for help.

CAUTION:

THIS UNIT IS A CLASS 1 LASER PRODUCT.

USE OF CONTROLS OR ADJUSTMENTS OR PERFORMANCE OF PROCEDURES OTHER THAN THOSE SPECIFIED HEREIN MAY RESULT IN HAZARDOUS RADIATION EXPOSURE.

AS THE LASER BEAM USED IN THIS UNIT IS HARMFUL TO THE EYES, DO NOT ATTEMPT TO DISASSEMBLE THE CABINET.

REFER SERVICING TO QUALIFIED PERSONNEL ONLY.

Note to CATV system installer:

This reminder is provided to call the CATV system installer’s attention to Article 820-40 of the National Electrical Code that provides guidelines for proper grounding and, in particular, specifies that the cable ground shall be connected to the grounding system of the building, as close to the point of cable entry as practical.

As an ENERGY STAR® Partner, SHARP has determined that this product meets the ENERGY STAR® guidelines for energy efficiency. ENERGY STAR is a U.S. registered mark.



IMPORTANT SAFEGUARDS

CAUTION: Please read all of these instructions before you operate this product and save these instructions for later use.

Electrical energy can perform many useful functions. This product has been engineered and manufactured to assure your personal safety. BUT IMPROPER USE CAN RESULT IN POTENTIAL ELECTRICAL SHOCK OR FIRE HAZARDS. In order not to defeat the safeguards incorporated in this product, observe the following basic rules for its installation, use and servicing.

1. **Read Instructions** – All the safety and operating instructions should be read before the product is operated.
 2. **Retain Instructions** – The safety and operating instructions should be retained for future reference.
 3. **Heed Warnings** – All warnings on the product and in the operating instructions should be adhered to.
 4. **Follow Instructions** – All operating and use instructions should be followed.
 5. **Cleaning** – Unplug this product from the wall outlet before cleaning. Do not use liquid cleaners or aerosol cleaners. Use a damp cloth for cleaning.
 6. **Attachments** – Do not use attachments not recommended by the product manufacturer as they may cause hazards.
 7. **Water and Moisture** – Do not use this product near water—for example, near a bath tub, wash bowl, kitchen sink, or laundry tub; in a wet basement; or near a swimming pool; and the like.
 8. **Accessories** – Do not place this product on an unstable cart, stand, tripod, bracket, or table. The product may fall, causing serious injury to a child or adult, and serious damage to the product. Use only with a cart, stand, tripod, bracket, or table recommended by the manufacturer, or sold with the product. Any mounting of the product should follow the manufacturer's instructions, and should use a mounting accessory recommended by the manufacturer.
 9. **Transportation** – A product and cart combination should be moved with care. Quick stops, excessive force, and uneven surfaces may cause the product and cart combination to overturn.
- 
10. **Ventilation**—Slots and openings in the cabinet are provided for ventilation to ensure reliable operation of the product and to protect it from overheating, and these openings must not be blocked or covered. The openings should never be blocked by placing the product on a bed, sofa, rug, or other similar surface. This product should not be placed in a built-in installation such as a bookcase or rack unless proper ventilation is provided or the manufacturer's instructions have been adhered to.
 11. **Power Sources** – This product should be operated only from the type of power source indicated on the marking label. If you are not sure of the type of power supply to your home, consult your product dealer or local power company. For products intended to operate from battery power, or other sources, refer to the operating instructions.
 12. **Grounding or Polarization** – This product is equipped with either a two-wire polarized plug (one plug blade bigger than the other) or a three-wire grounded plug (a third pin for grounding). The two-wire polarized plug will fit only one way into the power outlet. The three-wire grounded plug will fit only into a grounding-type power outlet.
If the plug does not fit, ask your electrician to replace your obsolete outlet. Do not modify the plug. To do so will void the safety feature.
 13. **Power-Cord Protection** – Power-supply cords should be routed so that they are not likely to be walked on or pinched by items placed upon or against them, paying particular attention to cords at plugs, convenience receptacles, and the point where they exit from the product.
 14. **Outdoor Antenna Grounding** – If an outside antenna or cable system is connected to the product, be sure the antenna or cable system is grounded so as to provide some protection against voltage surges and built-up static charges. Article 810 of the National Electrical Code, ANSI/NFPA 70, provides information with regard to proper grounding of the mast and supporting structure, grounding of the lead-in wire to an antenna discharge unit, size of grounding conductors, location of antenna-discharge unit, connection to grounding electrodes, and requirements for the grounding electrode. See diagram below.

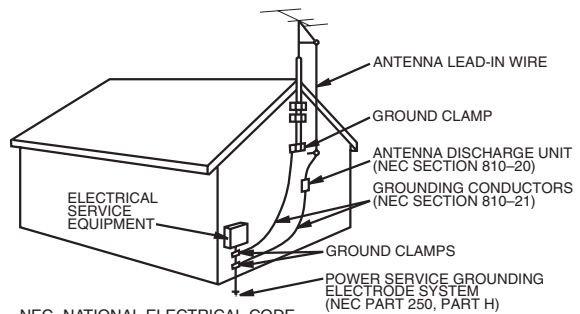

NEC- NATIONAL ELECTRICAL CODE

15. **Lightning** – For added protection for this product during a lightning storm, or when it is left unattended and unused for long periods of time, unplug it from the wall outlet and disconnect the antenna or cable system. This will prevent damage to the product due to lightning and power-line surges.
16. **Power Lines** – An outside antenna system should not be located in the vicinity of overhead power lines or other electric light or power circuits, or where it can fall into such power lines or circuits. When installing an outside antenna system, extreme care should be taken to keep from touching such power lines or circuits as contact with them might be fatal.
17. **Overloading** – Do not overload wall outlets, extension cords, or integral convenience receptacles as this can result in a risk of fire or electric shock.
18. **Object and Liquid Entry** – Never push objects of any kind into this product through openings as they may touch dangerous voltage points or short-out parts that could result in a fire or electric shock. Never spill liquid of any kind on the product.
19. **Servicing** – Do not attempt to service this product yourself as opening or removing covers may expose you to dangerous voltage or other hazards. Refer all servicing to qualified service personnel.
20. **Damage Requiring Service** – Unplug this product from the wall outlet and refer servicing to qualified service personnel under the following conditions:
 - a. When the power-supply cord or plug is damaged.
 - b. If liquid has been spilled, or objects have fallen into the product.
 - c. If the product has been exposed to rain or water.
 - d. If the product does not operate normally by following the operating instructions. Adjust only those controls that are covered by the operating instructions, as an improper adjustment of other controls may result in damage and will often require extensive work by a qualified technician to restore the product to normal operation.
 - e. If the product has been dropped or damaged in any way.
 - f. When the product exhibits a distinct change in performance, this indicates a need for service.
21. **Replacement Parts**—When replacement parts are required, be sure the service technician has used replacement parts specified by the manufacturer or have the same characteristics as the original part. Unauthorized substitutions may result in fire, electric shock, or other hazards.
22. **Safety Check**—Upon completion of any service or repairs to this product, ask the service technician to perform safety checks to determine that the product is in proper operating condition.
23. **Heat**—This product should be situated away from heat sources such as radiators, heat registers, stoves, or other products (including amplifiers) that produce heat.

Contents

IMPORTANT SAFEGUARDS	3	Change the Display on the TV Screen	28
Features	6	Change the Display on the Front Panel Display	28
Accessories	6	Playback.....	29
About Discs	7	DVD Playback	29
Types of Discs that Can Be Played on This Recorder ...	7	Playback the playback-only discs	29
Discs that Cannot be Played	7	Selected Title Playback	30
About Recording	9	Recorded DVD Disc Playback	30
Recording Format	9	Playback After Confirming Contents with DiscNavi ..	30
VR (Video Recording) Mode	9	Playback by Selecting a Title	31
Video Mode	9	Video CD/Audio CD/CD-R/CD-RW Playback	31
Discs and Recording Formats	9	Selected Track Playback	31
DVD-RW Discs	9	Fast Forward/Fast Reverse	32
DVD-R Discs	9	Fast Forward/Fast Reverse (Search) Function on the	
Recording Time	10	Recorder	32
Disc Remaining Time	10	SKIP (Forward/Reverse)	32
Cautions Regarding Recording	10	Slow-Motion	32
Using the Proper Disc	11	Still/Pause, Frame Advance	33
Unrecordable Material	11	Skip Search	33
Initialization and Finalization	12	MP3 Discs Playback.....	34
Initialization (Format)	12	To Play Another File (music title) during Playback	34
Allowing Discs to be Played Back		To Skip the File during Playback	34
with Other DVD Players (Finalization)	12	Changing Image/Audio During Playback..	35
About the Contents of the Disc	12	Zoom Function	35
Title, Chapter and Tracks	12	Angle Function	35
Icons Used on DVD Video Disc Case	13	Audio Setting	36
The icons used in this Operation Manual	13	Monitor Output when Receiving a Stereo or SAP	
Precautions During Use	14	Broadcast	36
Disc Precautions	14	DNR (Digital Noise Reduction)	36
Proper Disc Storage	14	Programmed Playback	37
Handling Precautions	14	Title/Track Programmed Playback	37
Cleaning the Pick Up Lens	14	Chapter Programmed Playback	38
Warning of Dew Formation	14	Repeat Playback.....	39
Copyright	14	Repeat Playback	39
Major Components.....	15	A-B Repeat Playback	39
Operating a TV Using the Remote Control		Function Control	40
(Universal Remote Control)	18	Direct Skip (title/chapter/track)	41
Setting the Remote Control Code	18	Direct Time Skip	41
Basic Connecton	19	Subtitle/Angle/Audio Setting	42
Easy Connection	19	Clearer Picture and Dynamic Sound Setting	43
Using Other Types of Video Output	20	DOLBY VIRTUAL SURROUND	43
Connecting Using an S-Video Output	20	DIGITAL GAMMA	43
Connecting Using the Component Video Output	20	DIGITAL SUPER PICTURE	43
CATV or Satellite Receiver Connections	21	DOLBY VIRTUAL SURROUND/DIGITAL GAMMA/	
Connecting to a Cable Box or Satellite Receiver (1)	21	DIGITAL SUPER PICTURE setting	44
Connecting to a Cable Box or Satellite Receiver (2)	22	Direct Selection of Scenes	
EZ Set Up	23	Selecting Scenes by Title Number	45
Channel Setting	24	Disc Menu Screen	45
Channel Setting	24	Recording for DVD Discs	
Adding Channel Memory/Erasing Channel Memory	24	Before Recording	46
Clock Setting	25	Recordable Discs	46
Auto Clock Setting	25	About the Recording Format	46
Manual Clock Setting	26	Before Starting Recording	46
Automatic Daylight Saving-Time (D.S.T.) Adjustment	26	Initialization	46
OSD Language Setting	27	Recording Formats and Recording Modes	47
Display Information.....	28	Disc Information	47
		Confirmation of Available Disc Space	47
		TV Program Recording	48
		Basic Recording	48
		Pause Recording	49
		Stop Recording	50
		Useful Recording Functions	50



Contents

Simple Recording Timer	51	DISC LANG.	81
Changing the Settings of the Simple Recording Timer ..	51	DD LEVEL (Dolby Digital Output Level)	81
Cancelling the Simple Recording Timer	51	□□Digital OUT	81
Timer Recording with VCR Plus+®		Basic Settings of the Playback Setup Screen	82
System	53	PARENTAL Level Setting	82
Timer Recording	54	DISC LANGUAGE Setting	84
Disc Timer Recording	56	Language Code List for Disc Language ...	85
Canceling the Disc Timer Recording	57	Record Setup Screen	86
Using the Recorder During Timer		CHP INT.	86
Standby Mode	58	EXACT REC	86
When Finished Using the Recorder	58	R REC START	86
Confirming/Cancelling Timer Program	59	EX. AUDIO	86
Automatic Recording of Satellite		D-MONO REC	86
Broadcast (AV AUTO REC)	60	RW INIT.	86
Connecting to a Satellite receiver, etc.	60	SAP	87
Recording with AV AUTO REC	60	Basic Settings of the Record Setup Screen	87
To Cancel the AV AUTO REC Function	61	Disc Setup Screen	88
Problems of Timer Recording	62	VR MODE INITIALIZE	88
Blinking the TIMER Indicator	62	VIDEO MODE INITIALIZE	88
When Timer Recording Times Overlap	62	FINALIZE	88
Editing the Disc	63	PROTECT	88
Before Editing the Disc	63	Basic Settings of the Disc Setup Screen	89
About Editing	63	Option Setup Screen	90
Editing Procedure	63	CLOCK DISP	90
Switching between Playlist and Original Playback ...	64	POWER OFF	90
Editing an Original Title	65	DUBBING	90
Erasing a Part from the Original	65	DV LINK	90
Inputting/Renaming the Title	66	DV AUDIO IN	91
Adding Chapter Markers	66	BLUE SCREEN	91
Erasing Chapter Markers	67	3D Y/C	91
Navimark	68	Basic Settings of the Option Setup Screen	92
Protecting the Title	69	Connecting to Audio Equipment	93
Cancelling the Protection	70	Playing 2 channel audio with an Analog Connector	93
Erasing a Title from the Original or Playlist	71	Playing Dolby Digital (5.1 channel)	
Erasing All Titles	71	and DTS audio with a Digital Connection	93
Erasing One Title	71	Playing 2 channel audio with a Digital Connection	94
Making a New Playlist (PL)	72	Recording by Connecting	
Making a Playlist from Original Title	72	with a Digital Camcorder Using i.LINK	95
Adding a Part to the Playlist	73	DV IN/OUT Terminal	95
Searching for Start Point and End Point Parts	74	Connecting Using the DV IN/OUT Terminal	
Editing a Playlist Title	75	(i.LINK)	95
Erasing a Part from the Playlist	75	Recording with this recorder (DV Uptake)	96
Moving the Title	75	Recording with a Digital Camcorder	97
Adding a Part from the Original to the Playlist	76	Recording Using an Analog Connection	
Adding Chapter Marker in a Playlist	77	with a Digital Camcorder	98
Erasing Chapter Marker in a Playlist	78	Recording with this Recorder	98
Renaming the Title	78	Recording Material from External Equipment	99
Navimark	78	Troubleshooting	100
Tamper Proof	79	Service Informatino (For the U.S.)	101
Tamper Proof Setting	79	Glossary	102
Disengaging Tamper Proof	79	Specifications	104
Operating during Tamper Proof	79	ESPAÑOL (Guía de operación rápida)	105
Playback Setup Screen	80		
TV MODE	80		
PROGRESSIVE	80		
PARENTAL	81		



Features

Playback Function

- **Powerful sound comparable to a movie theater**
Connecting this recorder to an AV amplifier compatible with Dolby Digital or DTS lets you enjoy powerful Surround sound filled with a sense of presence.
- **Find what you want to watch quickly and easily**
Unlike video tape, you can jump right to the part of a DVD disc that you want to watch without having to fast forward and rewind. You can also search for the scene you want to watch both quickly and easily.
- **DiscNavi**
The DiscNavi function lets you find the title you want to play back at a glance for easy playback. Lists of titles are displayed for finalized DVD-RW discs (discs recorded in the Video mode) and DVD-R discs.

Recording Function

- **Up to 8 programs of Timer recording**
- **VCR Plus+^{*1}**
*1 VCR Plus+ and PlusCode are registered trademarks of Gemstar Development Corporation. The VCR Plus+ system is manufactured under licence from Gemstar Development Corporation.
- **Simple Recording Timer**
- **Disc Timer Recording**
The disc timer recording function lets you program timer recordings onto a disc for added convenience when recording regular weekly programs.
- **Exact Rec**
This function automatically changes the recording mode to prevent recordings from running out before they are finished due to a lack of available disc space by comparing the available disc space and the time required for the timer recording.
- **AV AUTO REC**
Record the timer program automatically when connected to a satellite receiver, etc. with timer recording functions.

Audio Input/Output

- **Digital connection with a digital camcorder**
You can uptake, edit and store material from a digital camcorder equipped with a DV jack. In addition, you can also output material recorded with this recorder to a digital camcorder.

Edit Function

- **Editing a recorded material without changing an Original**
You can edit original recordings by creating a collection of titles (Playlist) without actually altering the recorded titles (originals).
- **Chapter Marker**
You can put a chapter marker anywhere in your desired point. This function is useful when you search the scene you want to watch with chapter skip function.
- **Erase/Move/Add Scenes**
You can make your desired Playlists to erase the scene, add the scene and move the scene.

Compatibility

- **Video mode recording that will be played back with other DVD players**
Discs recorded in the Video mode can be played back with other DVD players by finalizing them after recording. (However, this does not guarantee that these discs can be played back on all DVD players.)
* Recordings onto DVD-R/RW discs using the Video mode (video format) employ a new standard approved by the DVD Forum in 2000, and compatibility with this standard is left to the discretion of the respective DVD player manufacturer. Consequently, there are some models of DVD players and DVD-ROM drives that are unable to play back DVD-R/RW discs.

Disc Features and this Operation Manual

- The types of functions and operations that can be used for a particular disc vary depending on the features of that disc. In some cases, these functions and operations may differ from the descriptions given in this Operation Manual. In this event, follow the instructions given on the screen. This Operation Manual only covers basic disc operations.
- **For some operations, the [] or [] indicator may appear on the TV screen. This indicates that the operation described in this Operation Manual is not permitted for the current disc.**

Accessories

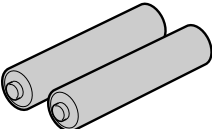
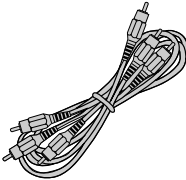
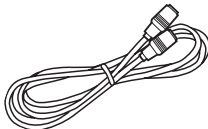
 <p>Remote control unit (RRMCGA056WJSA)</p>	 <p>Two "AA" size batteries (R-6, UM/SUM-3) for the remote control unit</p>	 <p>Video/Audio cable (QCNW-8388AJZZ)</p>	 <p>Round coaxial cable (75 Ohm, 1 m [3-1/4 ft.]) (QCNW-8387AJZZ)</p>
--	--	---	--





About Discs

Types of Discs that Can Be Played on This Recorder

- The following discs can be played back and recorded with this recorder. Do not use an 8 cm (3") adapter (for CDs).
- Since this recorder is compatible with the NTSC format, use discs that contain the letters "NTSC" on the disc or package.
- Use discs that are compatible with standards as indicated by the presence of the following logo marks on the disc label. Playback of discs not complying with these standards is not guaranteed. In addition, image quality or sound quality is not guaranteed even if such discs are able to be played back.





Discs For Recording and Playback

Types of Discs	Recording Format	Contents of Discs	Size of Discs
DVD-RW 	•Ver. 1.1 •Ver. 1.1 (CPRM compatible) ^{*1}	VR Mode Video Mode	12cm (5"), single-sided/double-sided, single layer disc
DVD-R 	Ver. 2.0	Video Mode	8cm (3"), single-sided, single layer disc ^{*2}

*1 "Copy-once" satellite broadcasts and other programs that can be recorded only once can be recorded.

*2 DVD-R/RW 8 cm (3") single-sided, single-layer discs can only be used for recording in the Video mode. Some discs of this type may not be able to be recorded.

Discs for Playback (Playback Only)

Types of Discs	Recording Format	Contents of Discs	Size of Discs
DVD Video 	Region number 	Video format	Audio + Video (Movie)
Video CD 	Video CD format	Audio + Video (Movie)	12cm (5") 8cm (3")
Audio CD ^{*3} 	Audio CD (CD-DA) format	Audio	
CD-R/CD-RW 	Audio CD (CD-DA) format	Audio	
	MP3 file format	Audio	
	Video CD format	Audio + Video (Movie)	

*3 This recorder has been designed on the premise of playing back Audio CDs that comply with CD (Compact Disc) standards. CDs containing a signal for the purpose of protecting copyrights (copy control signal) may not be able to be played back with this recorder.

- DVD video players and discs have region numbers, which dictate the regions in which a disc can be played. The region number for this product is **1**. (Discs marked **ALL** will play in any player.)
- The specific playback functionality for some DVD discs is determined by the disc manufacturer. Because this recorder plays disc data in accordance with the disc manufacturer's guidelines, some functions may not be available on some discs. Be sure to read the instructions provided with the disc.
- The "Prohibited" indicator  displayed on the TV screen during this product operation indicates that such manufacturer-imposed restrictions apply.
- If a menu screen or operating instructions are displayed during playback of a disc, follow the displayed operating procedure.

Discs that Cannot be Played

- **The following discs are unable to be played back or are not played back properly on this recorder. If such a disc is mistakenly played back, the speakers may be damaged due to the large volume. Never attempt to play back such discs.**

CDG, Photo CD, CD-ROM, CD-TEXT, CD-EXTRA, SVCD, SACD, PD, CDV, DVD-ROM, DVD-RAM, +RW, DVD-Audio

- **The following DVD video discs cannot be played.**

- Discs not containing "1" or "ALL" for the region number (Discs sold outside the authorized marketing area).^{*1}
- Discs recorded on PAL or SECAM format.^{*2}
- Discs produced illegally.
- Discs recorded for commercial use

*1The region number for this product is 1.

*2This recorder is compatible with the NTSC format. Make sure to check the format of the disc before purchasing.

- **The following CD-R/CD-RW discs cannot be played.**

- Discs on which data has not been recorded cannot be played back.
- Discs recorded in a format other than a Video CD/ Audio CD and MP3 file format cannot be played back.^{*3}
- Discs may not be able to be played back depending on their recording status or the status of the disc itself.
- Discs may not be able to be played back depending on their compatibility with this recorder.
- Discs may not be able to be played back depending on the recorder used for recording.
- Non-finalized discs cannot be played back.

About Discs

■ Discs with unusual shapes cannot be played.

- Discs with unusual shapes (heart-shaped or hexagonal discs, etc.) cannot be used. The use of such discs will cause a fault.

*3 About MP3 file format

MP3 files are audio data compressed in MPEG1 Audio layer 3 file format. "MP3 files" have ".mp3" as extensions. (Some files that have ".mp3" extensions or files that have not been recorded in MP3 format will produce noise or cannot be played.)

● Playing MP3 discs

- Some MP3 files are not played in the order they were recorded.
- The number of layers which can be recognized, including files and folders, is maximum of 8.
- Some multi-session discs cannot be played.
- It is recommended to record data at a lower speed as data recorded at fast speed can produce noise and may not be able to be played.
- The more folders there are, the longer the reading time.
- Depending on the folder tree, reading MP3 files can take time.
- Folder or track (file) names are limited to 8 characters. Folder or track (file) names that go over 8 characters will be abbreviated. (Certain letters or symbols in folder names or title name may not be displayed.)
- The playing time may not be correctly displayed during MP3 file playback.

● The following files cannot be played on this recorder

- Discs that have more than 1000 folders and files in total.
- When both Audio CD format and MP3 files format are recorded on a disc. (The disc is recognized to be an Audio CD and only tracks in the Audio CD format are played back.)



About Recording

Recording Format

- There are two recording formats available with this recorder consisting of the VR mode and Video mode.
- The recording format that can be selected may differ depending on the disc. Refer to the section on Discs and Recording Formats.

VR (Video Recording) Mode

The VR mode is the basic DVD-RW recording format, and lets you enjoy the various editing functions available with this recorder.

- When a disc has been recorded in the VR mode, it can be recorded and erased repeatedly. Erasure also allows the recording time to be increased.
- Recorded discs can only be played back with DVD-RW-compatible DVD players*1.
- "Copy-once" programs can also be recorded*2.

- *1: • Although there are some cases in which the disc must be finalized, the disc can be recorded and erased after it has been finalized.
- The following mark is indicated on DVD-RW-compatible DVD players.



This mark indicates that the player on which it is indicated has the function of being able to play back DVD-RW discs recorded in the VR mode with a DVD recorder.

- *2: When using a disc compatible with DVD-RW Ver. 1.1 (CPRM). Recorded programs cannot be played back with other DVD players (including DVD-RW players) or DVD recorders not compatible with CPRM.

Video Mode

This recording format is compatible with commercially available DVD players and DVD-ROM drives.

- Discs recorded in the Video mode can be played back with other DVD players by finalizing them after recording. (However, this does not guarantee that these discs can be played back on all DVD players.)
- When recording in the Video mode, discs can be played back, additionally recorded and edited only with this recorder until they are finalized. Editing-functions are limited.
- Recordings onto DVD-R/RW discs using the Video mode (video format) employ a new standard approved by the DVD Forum in 2000, and compatibility with this standard is left to the discretion of the respective DVD player manufacturer. Consequently, there are some models of DVD players and DVD-ROM drives that are unable to play back DVD-R/RW discs.
- "Copy-once" programs cannot be recorded.

Discs and Recording Formats

- DVD-RW and DVD-R discs can be recorded with this recorder. The recording format that can be selected may vary according to the disc version and types of disc.

Types of Discs	Recording Formats	
	VR Mode	Video Mode
DVD-RW Ver. 1.1	×	×
DVD-RW Ver. 1.1 (CPRM compatible)	×	×
DVD-R	—	×

Make sure to use a disc that has the words "For Video" or "For recording" on the disc or disc jacket for recording and playback with this recorder.

DVD-RW Discs

- DVD-RW discs are available in Ver. 1.1 or Ver. 1.1 (CPRM).
- Ver. 1.1 discs can be recorded in either the VR mode or Video mode*1.
- In the case a disc has been recorded in the VR mode, it can be recorded and erased repeatedly. Erasure also allows the recording time to be increased.
- In the case a disc has been recorded in the Video mode, although additional recordings can be made until the disc is full, recording time cannot be increased by erasure*2.
- When a disc is initialized, all of its recorded contents can be erased allowing it to be recorded even if it has been recorded in the Video mode. (Refer to pages 12 and 88 regarding initialization.)

*1: Recordings in the VR mode and Video mode cannot be mixed on one disc.

*2: Recording time can only be increased when the last title is erased (titles cannot be erased after a disc has been finalized).

DVD-R Discs

- DVD-R discs can only be recorded in the Video mode.
- Although additional recordings can be made until the disc is full, disc space does not increase even if titles are erased (because erasure here refers only to making the titles not visible).
- Although these discs can be played back with other DVD players once they have been finalized, the discs can no longer be recorded or erased after they have been finalized.
- Discs can be additionally recorded and edited with this recorder only until they are finalized.

! Important!

This recorder cannot be used to record CD-R or CD-RW discs.



About Recording

Recording Time

- The recording mode that can be set varies according to the recording format. Refer to the table below for the applicable recording mode.

Recording Mode	Recordable Time	Recording format		Description
		VR Mode	Video Mode	
FINE	About 60 minutes (About 90 minutes)	×	×	When you want to record high-quality images
SP	About 120 minutes (About 180 minutes)	×	×	This is the standard recording mode
LP	About 240 minutes (About 300 minutes)	×	×	When you want to record for a long period of time with slightly lower image quality
EP	About 360 minutes	×		When you want to place priority on recording time

- Recordable time is based on the recording time when using a 4.7 GB disc. Since recording capacity varies according to the recorded material, there may be times where there is much more disc space remaining on the disc when recording is completed.
- Values for recording time shown in parentheses () indicate the time of Exact Rec. function. (A recordable time of about 300 minutes in the LP mode is the recordable time in the VR mode.)
- * Since recording by DVD is performed using VBR (variable bit rate, refer to the section on VBR Control on page 103) with the exception of some recording modes, recording time varies according to the recorded material.

- Recordable time may be shorter than that indicated above in the case of recording material of poor image quality such as broadcasts from televisions with poor reception.
- The total of recording time and remaining time may not always agree with the recordable time of the recording mode.
- Block-like images may become conspicuous during scenes containing rapid movement due to the characteristics of digital image compression technology.

Disc Remaining Time

- VR Mode**
 - Additional recordings can be made as long as there is available space on the disc. (Additional recordings can also be made after the disc is finalized.)
 - Erasing unnecessary original recordings (page 71) lets you increase the remaining time on the disc. (The disc can also be erased after it has been finalized.)

Video Mode

- Additional recordings can be made with this recorder provided there is available space on the disc until the disc is finalized. (Additional recordings and erasure cannot be performed once the disc has been finalized.)
- The remaining time cannot be returned to the status prior to recording, and recordings cannot be overwritten.
- The "Erase Title" editing function is for not displaying unnecessary titles. The available disc space does not increase. (In the case of DVD-RW discs, available disc space can be increased only by erasing the last title provided the disc has not yet been finalized.)

Cautions Regarding Recording

When Recording in the Video Mode

- Since images are recorded in 30 second units (1 minute units in the LP mode), images may be recorded briefly after recording has been stopped.
- When recording onto a DVD-R disc, press **●REC** twice. If **●REC** is only pressed once, recording will be paused. Recording starts when **●REC** is pressed again. (The procedure for starting a recording can be changed (page 86)).

Always Make Sure to Test Record First

- Make a test recording with a DVD-RW disc (VR mode) first before making any important recordings to confirm whether or not the recorded material is recorded properly.

Compensation for Recordings

- In the event a recording is unable to be made due to a problem with this recorder or a disc, or due to an external factor such as a power failure or condensation of moisture and so forth, the manufacturer is not responsible for compensation for unrecorded contents or incidental damages.

Be Careful of Scratches and Dust

- DVD-R and DVD-RW discs are sensitive to dust, fingerprints and especially scratches. A scratched disc may not be able to be recorded, or important data recorded may not be able to be played back. Handle discs with care and store them in a safe place.**







About Recording

Using the Proper Disc

Select the disc used and recording format according to the objective of the recording.

Select the disc and recording format by referring to the table below.

Objective	Disc Used	Recording Format
<ul style="list-style-type: none"> When you want to play back a recorded disc with a DVD player or DVD video-compatible PC When not re-recording a recorded disc (when making a permanent recording or when you do not want the recording to be erased) 	Recordable DVD-R disc 	Video mode recording + finalization processing
<ul style="list-style-type: none"> When you want to play back a recorded disc with a DVD player or DVD Video-compatible PC When you want to repeatedly record and erase a recorded disc 	Recordable DVD-RW disc Ver. 1.1 or Ver. 1.1 (CPRM-compatible) 	Video mode recording + finalization processing
<ul style="list-style-type: none"> When you want to edit a disc recorded with this recorder When playing back with a DVD-RW-compatible player (a player containing the mark indicated below)  When you want to repeatedly record and erase a recorded disc 	Recordable DVD-RW disc Ver. 1.1 or Ver. 1.1 (CPRM-compatible) 	VR mode recording + (finalization processing)
<ul style="list-style-type: none"> When you want to record a "copy-once" satellite broadcast, etc. 	Recordable DVD-RW disc Ver. 1.1 (CPRM-compatible) 	VR mode recording

Unrecordable Material

- Video recordings protected by a copy guard (a signal that controls copying to prevent recording) cannot be recorded.
Example:
 - DVD videos
 - PPV (pay-per-view) broadcasts
- The proper image may not be able to be obtained in the case a copy guard is contained in the images of equipment connected to the external input jacks (IN 1, IN 2, IN 3 or DV) of this recorder.
Example:
 - Images not output at proper brightness
 - Incorrect output of picture size (page 80) and other data
Connect such equipment directly to your TV without going through this recorder.
- In the case a copy guard signal is contained in a source video that occurs partway through recording, recording is paused at that point. Recording resumes when the copy guard signal is no longer present, while no recordings will be made for the part where the copy prevention signal is present.
- This recorder is equipped with a copy guard function that prevents recording of video software or broadcast programs that contain a signal that restricts copying in accordance with copyrights and so forth.

Initialization and Finalization

Initialization (Format)

Initialization is required when using DVD-RW discs in the Video mode. (See page 88 for details about Initialization)

When an unused DVD-RW disc is placed in the recorder immediately after it has been purchased, the recorder is set to automatically begin initializing in the VR mode. The settings can also be changed so that discs are initialized in the Video mode (page 86).

When using a DVD-RW disc in the Video mode without changing this setting, initialize the disc in the Video mode after first completing initialization in the VR mode (page 88).

- Initialization causes the entire previously recorded contents of the disc to be erased.
- It takes about 1 minute to 1 minute and 30 seconds for initialization to be completed.

Allowing Discs to be Played Back with Other DVD Players (Finalization)

Discs must always be finalized in order to play them back with another DVD player after having been recorded in the Video mode. (See page 88 for details about Finalization)

Finalize discs on which all recordings have been completed so that they can be viewed with another DVD player or a DVD video-compatible PC. Discs that are not finalized may not be able to be played back with other DVD players or DVD video-compatible PCs. (However, this does not guarantee that finalized discs can be played back on all DVD players or DVD video-compatible PCs.)

- Finalizing a DVD-R disc prevents all recording and editing of that disc.
- Although DVD-RW discs can be re-recorded by initializing even after they have been recorded in the Video mode and finalized, all previously recorded contents are erased.
- Finalizing is required if a disc recorded in the VR mode cannot be played back with a DVD-RW-compatible player. (Discs can be recorded and edited even after finalizing in the case of the VR mode.)
- Finalizing takes from several minutes to about an hour. (Processing takes longer time if there is considerable available space on the disc.)

About the Contents of the Disc

Title, Chapter and Tracks

- DVDs are divided into "Titles" and "Chapters". If the disc has more than one movie on it, each movie would be a separate "Title". "Chapters", on the other hand, are subdivisions of titles.

Example: DVD

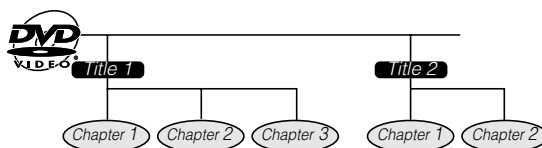

- Video CDs and Audio CDs are divided into "Tracks". You can think of a "Track" as one tune on an Audio CD.

Example: Video CDs or Audio CD



Recording on a DVD-RW Disc in the VR Mode

An once recording is treated as a single title (or one chapter). However, a chapter marker (division) is inserted automatically if the recording is paused or a scene is erased during editing. In addition, you can also insert a chapter marker (division) at your favorite scene (page 66).

Recording on a DVD-R or DVD-RW Disc in the Video Mode

An once recording is treated as a single title, and recordings are automatically divided into chapters every 3 minutes. Although the interval at which recordings are divided into chapters can be changed to either 3 minutes, 5 minutes, 10 minutes, 15 minutes, 30 minutes or off (page 86), you cannot insert a chapter at a desired scene.

NOTE

- Numbers identify each title, chapter, and track on a disc. Most discs have these numbers recorded on them, but some do not.

About the Contents of the Disc

Icons Used on DVD Video Disc Case

When you buy a DVD Video disc, the back of the disc case usually contains various information about the contents of the disc.

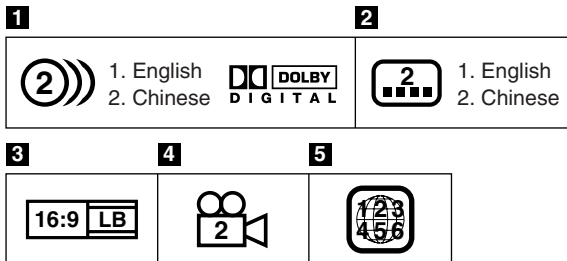

1 Audio tracks and audio formats

DVD discs can contain up to 8 separate tracks with a different language on each. The first in the list is the original track.

This section also details the audio format of each soundtrack—Dolby Digital, DTS, etc.

Dolby Digital

A sound system developed by Dolby Laboratories Inc. that gives movie theater ambience to audio output when the recorder is connected to a Dolby Digital 5.1 channel processor or amplifier.

DTS

DTS is a digital sound system developed by Digital Theater Systems for use in cinemas. This system uses 6 audio channels and provides accurate sound field positioning and realistic acoustics. (By Connecting a DTS Digital Surround decoder, you can also listen to DTS Digital Surround sound.)

Linear PCM

Linear PCM is a signal recording format used for Audio CDs.

The sound on Audio CDs is recorded at 44.1 kHz with 16 bits. (On DVD discs, sound is recorded at between 48 kHz with 16 bits and 96 kHz with 24 bits.)

2 Subtitle languages

This indicates the kind of subtitles.

3 Screen aspect ratio

Movies are shot in a variety of screen modes.

4 Camera Angle

Recorded onto some DVD discs are scenes, which have been simultaneously shot from a number of different angles (the same scene is shot from the front, from the left side, from the right side, etc.).

5 Region code

This indicates the region code (playable region number).





The icons used in this Operation Manual

DVD VIDEO	Indicates the functions that can be performed for DVD Video discs.
DVD RW VR MODE	DVD RW VIDEO MODE
		Indicates the functions that can be performed for DVD-RW discs.
		VR MODE:
		• Indicates the functions that can be recording in VR mode or playback a disc recorded in VR mode.
		VIDEO MODE:
		• Indicates the functions that can be recording in Video mode or playback a disc recorded in Video mode.
DVD R	Indicates the functions that can be performed for DVD-R discs.
VIDEO CD	Indicates the functions that can be performed for Video CDs.
AUDIO CD	Indicates the functions that can be performed for Audio CDs.
CD-R	Indicates the functions that can be performed for CD-R.
CD-RW	Indicates the functions that can be performed for CD-RW.

Precautions During Use

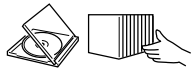
Disc Precautions

Proper Disc Storage

Place the disc in the center of the disc case and store the case and disc upright.	
Avoid storing discs in locations subject to direct sunlight, next to heating appliances or in locations of high humidity.	
Do not drop discs or subject them to strong vibrations or impacts.	
Avoid storing discs in locations where there are large amounts of dust or locations where mold tends to grow easily.	

Handling Precautions



- If the surface is soiled, wipe gently with a soft, damp (water only) cloth. When wiping discs, always move the cloth from the center hole toward the outer edge.
- Do not use record cleaning sprays, benzene, thinner, static electric prevention liquids or any other solvent.
- Do not touch the surface.
- Do not stick paper or adhesive labels to the disc.
- If the playing surface of a disc is soiled or scratched, the recorder may decide that the disc is incompatible and eject the disc tray, or it may fail to play the disc correctly. Wipe any soiling off the playing surface with a soft cloth.

Cleaning the Pick Up Lens

- Never use commercially available cleaning discs. The use of these discs can damage the lens.
- Request cleaning of the lens to the nearest Sharp Authorized Service Center.

Warning of Dew Formation

- Dew may form on pick up lens or disc in the following conditions:
 - Immediately after a heater has been turned on.
 - In a steamy or very humid room.
 - When the recorder is suddenly moved from a cold environment to a warm one.



When dew forms: It becomes difficult for the recorder to read the signals on the disc and prevents the recorder from operating properly.

To remove dew: Take out the disc and leave the power on for about 1 hour. The recorder will again operate properly when the dew has evaporated.

Copyright

- It is the intent of Sharp that this product be used in full compliance with the copyright laws of the United States and that prior permission be obtained from copyright owners whenever necessary.
- This product incorporates copyright protection technology that is protected by method claims of certain U.S. patents and other intellectual property right owned by Macrovision Corporation and other rights owners. Use of this copyright protection technology must be authorized by Macrovision Corporation, and is intended for home and other limited viewing uses only unless otherwise authorized by Macrovision Corporation. Reverse engineering or disassembly is prohibited.

Apparatus Claims of U.S. Patent Nos. 4,631,603, 4,577,216, 4,819,098 and 4,907,093 licensed for limited viewing uses only.

- Manufactured under license from Dolby Laboratories. "Dolby", "Pro Logic" and the double-D symbol are trademarks of Dolby Laboratories.
- "DTS" and "DTS Digital Surround" are trademarks of Digital Theater Systems, Inc.
- Certain audio features of this product manufactured under a license from Desper Products, Inc. Spatializer® N-2-2™ and the circle-in-square device are trademarks owned by Desper Products, Inc.
- DVD logo are registered trademark.
- i.Link refers to the IEEE 1394-1995 industry specification and extensions thereof. The  logo is used for products compliant with the i.Link standard.
-  are trademark.

"Licensed under one or more of U.S. Pat. 4,972,484, 5,214,678, 5,323,396, 5,530,655, 5,539,829, 5,544,247, 5,606,618, 5,610,985, 5,740,317, 5,777,992, 5,878,080 or 5,960,037."

Major Components

Main Unit (Front)

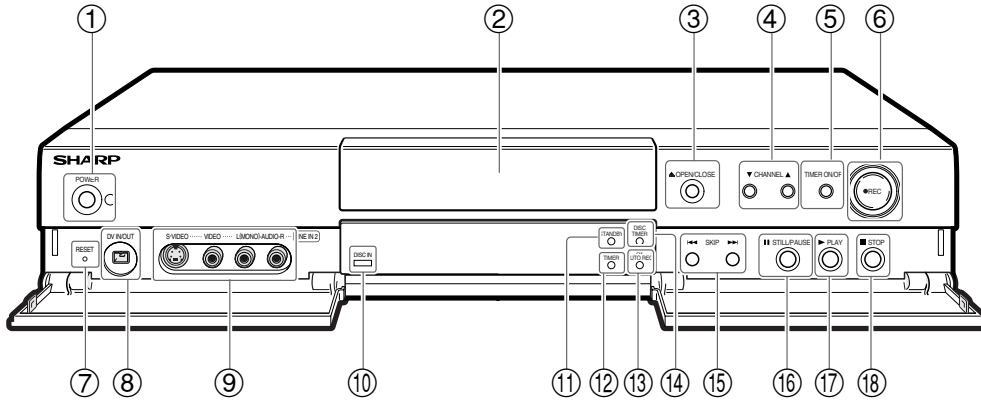

- | | |
|-----------------------------|--------------------------------|
| ① POWER (P.29) | ⑩ DISC IN indicator (P.29) |
| ② Disc tray (P.29) | ⑪ STANDBY indicator (P.28) |
| ③ ▲ OPEN/CLOSE (P.29) | ⑫ TIMER indicator (P.53) |
| ④ CHANNEL ▼/▲ (P.24) | ⑬ AV AUTO REC indicator (P.61) |
| ⑤ TIMER ON/OFF (P.52) | ⑭ DISC TIMER indicator (P.56) |
| ⑥ ● REC (P.48) | ⑮ SKIP ◀◀/▶▶ (P.32) |
| ⑦ RESET (P.101) | ⑯ ■ STILL/PAUSE (P.33) |
| ⑧ DV IN/OUT terminal (P.95) | ⑰ ▶ PLAY (P.29) |
| ⑨ LINE IN 2 | ⑱ ■ STOP (P.29) |
| · AUDIO input jacks | |
| · VIDEO input jack | |
| · S-VIDEO input jack | |

Front Panel Display

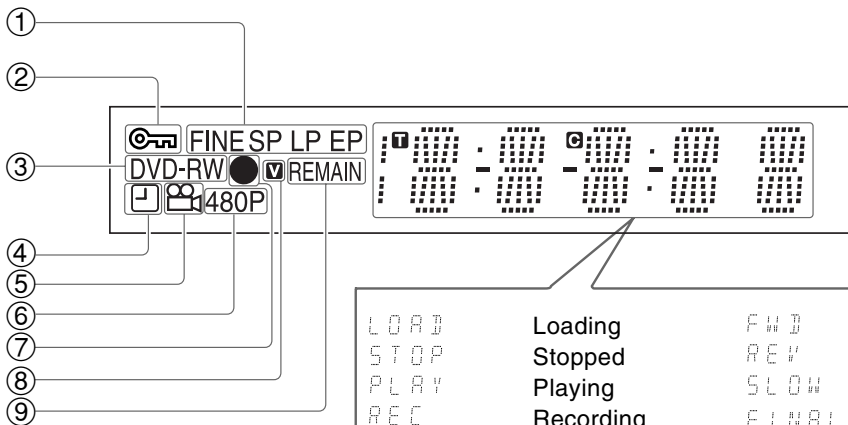

LOAD	Loading	FWD	Fast forward
STOP	Stopped	REV	Fast reverse
PLAY	Playing	SLOW	Slow
REC	Recording	FINALIZE	Finalize
RESTORE	Restore	INITIALIZE	Initialize
STILL	Still/Pause	WRITE	Writing disc management information
OPEN	Tray open		
CLOSE	Tray closed		
PAUSE	Recording Pause	ERASE	Erasing

- | | |
|---|-------------------------------------|
| ① Recording Mode indicator (P.48) | ⑥ Progressive indicator (P.80) |
| ② Tamper Proof indicator (P.79) | ⑦ Recording mark (P.48) |
| ③ Disc Type indicator | ⑧ Video mode disc-in indicator |
| ④ Simple Timer Recording indicator (P.51) | ⑨ Disc remain time indicator (P.28) |
| ⑤ Angle indicator (P.35) | |

Major Components

Main Unit (Rear)

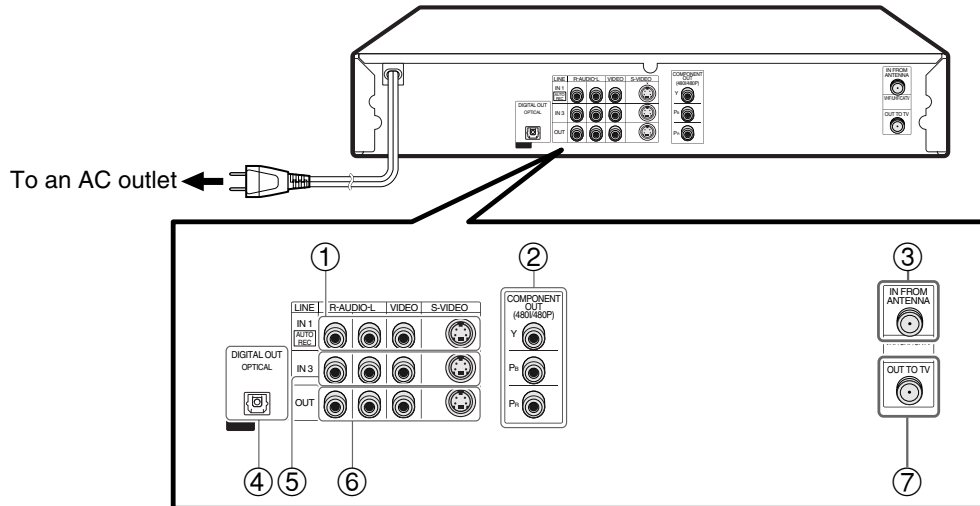

- ① LINE IN 1 (AUTO REC)
 - AUDIO input jacks
 - VIDEO input jack
 - S-VIDEO input jack
- ② COMPONENT VIDEO output jacks (P.20)
- ③ ANTENNA IN (antenna or cable input) (P.19)
- ④ DIGITAL OUT OPTICAL terminal (P.93)
- ⑤ LINE IN 3
 - AUDIO input jacks
 - VIDEO input jack
 - S-VIDEO input jack
- ⑥ Output jacks
 - AUDIO output jacks
 - VIDEO output jack
 - S-VIDEO output jack
- ⑦ ANTENNA OUT (P.19)



Major Components

Remote Control Unit

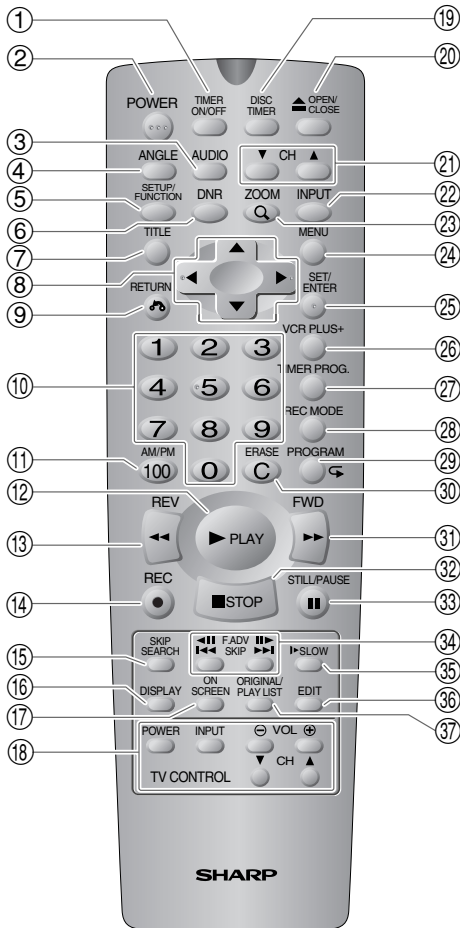

Operating Range of Remote Control

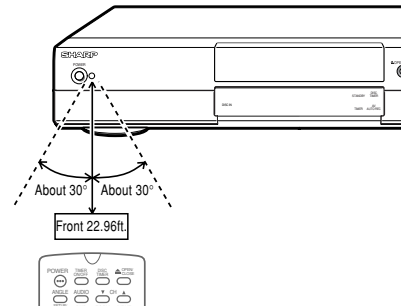

- | | |
|--|--|
| ① TIMER ON/OFF (P.52) | ⑳ OPEN/CLOSE (P.29) |
| ② POWER (P.29) | ㉑ CH ∇/\blacktriangle (P.24) |
| ③ AUDIO (P.36) | ㉒ INPUT (P.96) |
| ④ ANGLE (P.35) | ㉓ ZOOM (P.35) |
| ⑤ SETUP/FUNCTION (P.24) | ㉔ MENU (P.30) |
| ⑥ DNR (P.36) | ㉕ SET/ENTER (P.24) |
| ⑦ TITLE (P.30) | ㉖ VCR PLUS+ (P.52) |
| ⑧ CURSOR ($\blacktriangle/\blacktriangledown/\blacktriangleleft/\blacktriangleright$) (P.24) | ㉗ TIMER PROG. (P.54) |
| ⑨ RETURN (P.27) | ㉘ REC MODE (P.48) |
| ⑩ Number buttons (P.24) | ㉙ PROGRAM (P.37)/
↶ [REPEAT] (P.39) |
| ⑪ 100, AM/PM (P.26) | ㉚ ERASE (P.37) |
| ⑫ \blacktriangleright PLAY (P.29) | ㉛ \blacktriangleright FWD (P.32) |
| ⑬ \blacktriangleleft REV (P.32) | ㉜ \blacksquare STOP (P.29) |
| ⑭ \bullet REC (P.48) | ㉝ \parallel STILL/PAUSE (P.33) |
| ⑮ SKIP SEARCH (P.33) | ㉞ $\blacktriangleleft\parallel\blacktriangleright$ F.ADV $\parallel\blacktriangleright$ (P.33),
$\blacktriangleleft\parallel\blacktriangleright$ SKIP $\parallel\blacktriangleright$ (P.32) |
| ⑯ DISPLAY (P.28) | ㉟ \blacktriangleright SLOW (P.32) |
| ⑰ ON SCREEN (P.28) | ㊱ EDIT (P.64) |
| ⑱ TV Function Control (P.18)
(Power/INPUT/VOL/CH) | ㊲ ORIGINAL/PLAY LIST (P.30) |
| ㉟ DISC TIMER (P.56) | |

Loading the Batteries

1 Open the battery cover by pulling the lid in the direction of the arrow.

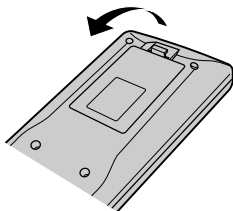

2 Load the batteries. Load the two "AA" size batteries (R6, UM/SUM-3) supplied with the remote control unit so that the battery poles \oplus and \ominus are positioned as indicated.

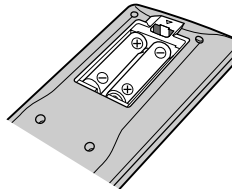

3 Close the battery cover by lowering the lid in the direction of the arrow.

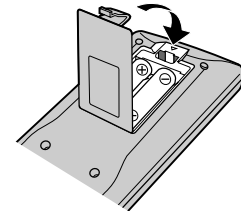

NOTE

- Do not subject the remote control unit to shock, water or excessive humidity.
- The remote control unit may not function if the recorder's sensor is in direct sunlight or any other strong light.
- Incorrect use of batteries may cause them to leak or burst. Read the battery warnings and use the batteries properly.
- Do not mix old and new batteries, or mix brands in use.
- Remove the batteries if you do not use the remote control unit for an extended period of time.



Major Components



Operating a TV Using the Remote Control (Universal Remote Control)

The Universal Remote Control may operate the basic functions of 21 different types of TVs. To enter the Manufacturer's Code for your TV, follow the instructions below.

There is no guarantee that the universal remote control will function with your TV.

Setting the Manufacturer's Code

- 1** Press **POWER** and **CH ▲** of TV CONTROL simultaneously.
- 2** Enter the 2-digit Manufacturer's Code with the number buttons (Ex. 02-"0", "2") within 10 seconds after releasing **POWER** and **CH ▲** of TV CONTROL.
- 3** Point the remote control unit towards the TV and then press **POWER** of TV CONTROL.
 - If the TV turns on/off, setup was successful. If not, repeat the procedure using another code.

Refer to the list below for the Manufacturer's Code and the buttons which work with each brand.

Buttons on the Remote		POWER CH ▲▼ VOL ⊕/⊖	INPUT
Brand	Code		
EMERSON	19	x	x
FISHER	17	x	x
FUNAI	06	x	x
GE	07, 09	x	—
GOLDSTAR	18	x	—
HITACHI	15	x	x
JVC	16	x	x
MAGNAVOX	09 11	x x	— x
mitsubishi	14	x	x
PANASONIC	13, 21	x	x
PIONEER	03	x	x
RCA	07, 09	x	—
SAMSUNG	20	x	x
SANYO	17	x	x
SHARP	01 02	x x	x x
SONY	10	x	x
TECHNOL ACE	04	x	x
TOSHIBA	12	x	x
ZENITH	05 08	x x	x —

NOTE

- If the batteries in the remote control unit are changed, the code settings must be re-entered.
- Some brands have more than one code listed above, due to changes in the codes. In such cases, try another code to find the code that operates your TV.

Setting the Remote Control Code

- There are two types of codes (remote control codes) for operating this recorder with the remote control (RC1 and RC2). If you operate this recorder with the remote control while using with another SHARP DVD recorder or DVD player placed next to it and both units end up being operated simultaneously, switching the remote control code (for both the recorder and the remote control) to one of the two signals (RC1 or RC2) will let you operate only the recorder.
- Make sure to set the recorder and remote control to the same remote control code. You will not be able to operate the recorder with the remote control if different remote control codes are used.

Important!

If the remote control codes of the recorder and remote control are different, the remote control code will flash on the display of the recorder. Reset the remote control number to the code flashing on the display.

Note

- The remote control code of the remote become "RC 1" when you change the batteries.

Setting the Remote Control Code of the Recorder

- 1** Press **POWER** to turn off the recorder.
- 2** Press and hold **CHANNEL ▼** and **▲** on the recorder together for more than 5 seconds.
 - Each time the button is pressed, the code of the recorder toggles between "RC-1" and "RC-2".
 - At this point, the recorder can no longer be operated with the remote control. Next, set the remote control code for the remote control.

Setting the Remote Control Code of the Remote

Example: Setting the "RC2".

- 1** Press and hold **POWER** and **2** together for more than 5 seconds.
 - When you set the code to "RC1", press and hold **POWER** and **1** together.
- 2** The recorder is turned on.

Basic Connection

Easy Connection

The following connection is the basic connection to watch or record TV programs. To use cable box or satellite receiver, see "CATV or Satellite Receiver Connections" on page 21.

Important!

- This recorder is equipped with copy protection technology. The playback picture from this recorder will not appear correctly on your TV when you connect this recorder to your TV via a VCR (or your VCR via this recorder) using Video/Audio cables.
- Be sure to turn off and unplug from the wall outlet this recorder and all equipments before connecting the cables.

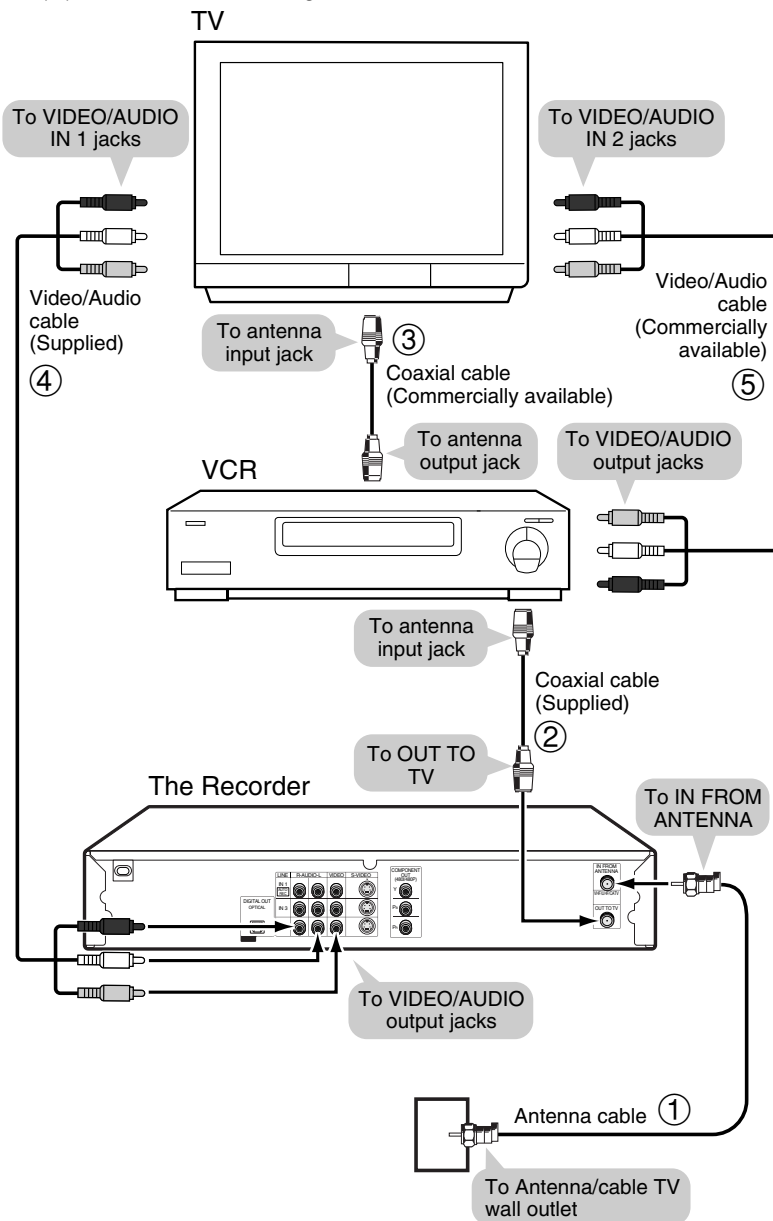

1 Connect the TV antenna cable to the IN FROM ANTENNA jack on the rear of this recorder.

2 Connect the OUT TO TV jack on the rear of this recorder to the antenna input jack on your VCR using a coaxial cable.

NOTE

- If you connect this recorder directly to your TV, skip the next step.
- The input signal to IN FROM ANTENNA jack is passed through to the OUT TO TV jack.

3 Connect the antenna output jack on your VCR to antenna input jack on your TV using a coaxial cable.

4 Connect the VIDEO/AUDIO output jacks on this recorder to the VIDEO/AUDIO input jacks on your TV using a Video/Audio cable.

Be sure that the colors of the jacks and plugs match up when connecting the cable.

NOTE

- To connect using S-Video or component cables, see "Using other types of video output" on the next page.

5 Connect the VIDEO/AUDIO output jacks on your VCR to the VIDEO/AUDIO input jacks on your TV using a Video/Audio cable.

Important!

- When using this connection, set "PROGRESSIVE" in "PLAYBACK SETUP" to "OFF". (When the setting is "ON", the disc playback picture cannot be viewed.)

After the Connection

Plug in the power cords of the TV and VCR. Then go to "EZ Set Up" (see page 23).

Basic Connection

Using Other Types of Video Output

In order to view clearer DVD images, it is recommended that you use a commercially available S-Video or component video cable when connecting your TV to the video output.

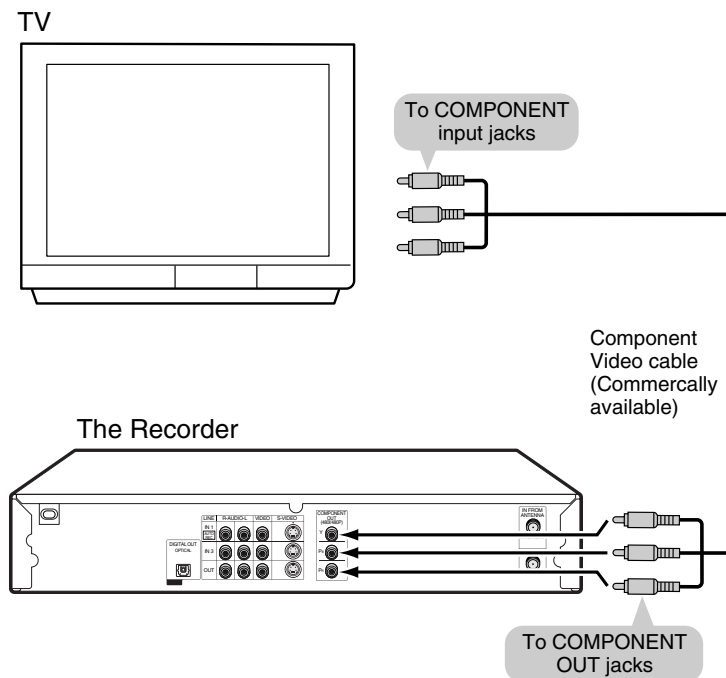
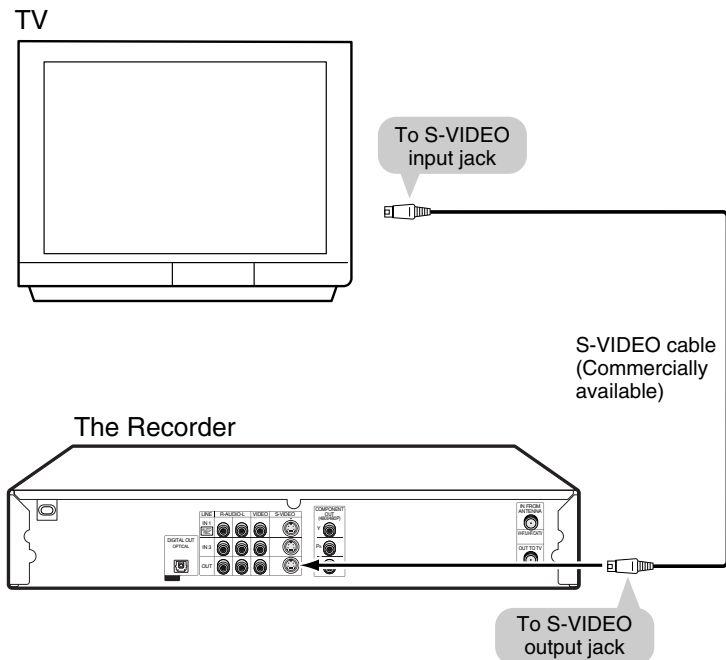

Connecting Using an S-Video Output

Connect the S-VIDEO output jack on this recorder to the S-VIDEO input jack on your TV using a S-VIDEO cable (Commercially available).

! Important!

- When using this connection, set "PROGRESSIVE" in "PLAYBACK SETUP" to "OFF". (When the setting is "ON", the disc playback picture cannot be viewed.)

After the Connection

Plug in the power cords of the TV. Then go to "EZ Set Up" (see page 23).

Connecting Using the Component Video Output

Connect the COMPONENT OUT jacks on this recorder to the COMPONENT input jacks on your TV using a Component Video cable (Commercially available).

! Important!

- If your TV is compatible with progressive-scan component video, set "PROGRESSIVE" in "PLAYBACK SETUP" to "ON". If your TV is not compatible with progressive-scan video, set to "OFF".

After the Connection

Plug in the power cords of the TV. Then go to "EZ Set Up" (see page 23).

CATV or Satellite Receiver Connections

Connecting to a Cable Box or Satellite Receiver (1)

The following connection is the connection to a cable box or satellite receiver when receiving only a few scrambled channels. When many or all the channels are scrambled, see the connection on the next page.

Using this connection, you can:

- Record unscrambled CATV signals by selecting them on this recorder.
- Record scrambled CATV signals by selecting them on the cable box or satellite receiver and using AV AUTO REC function (See page 60).
- Record another channel while you watch one channel.

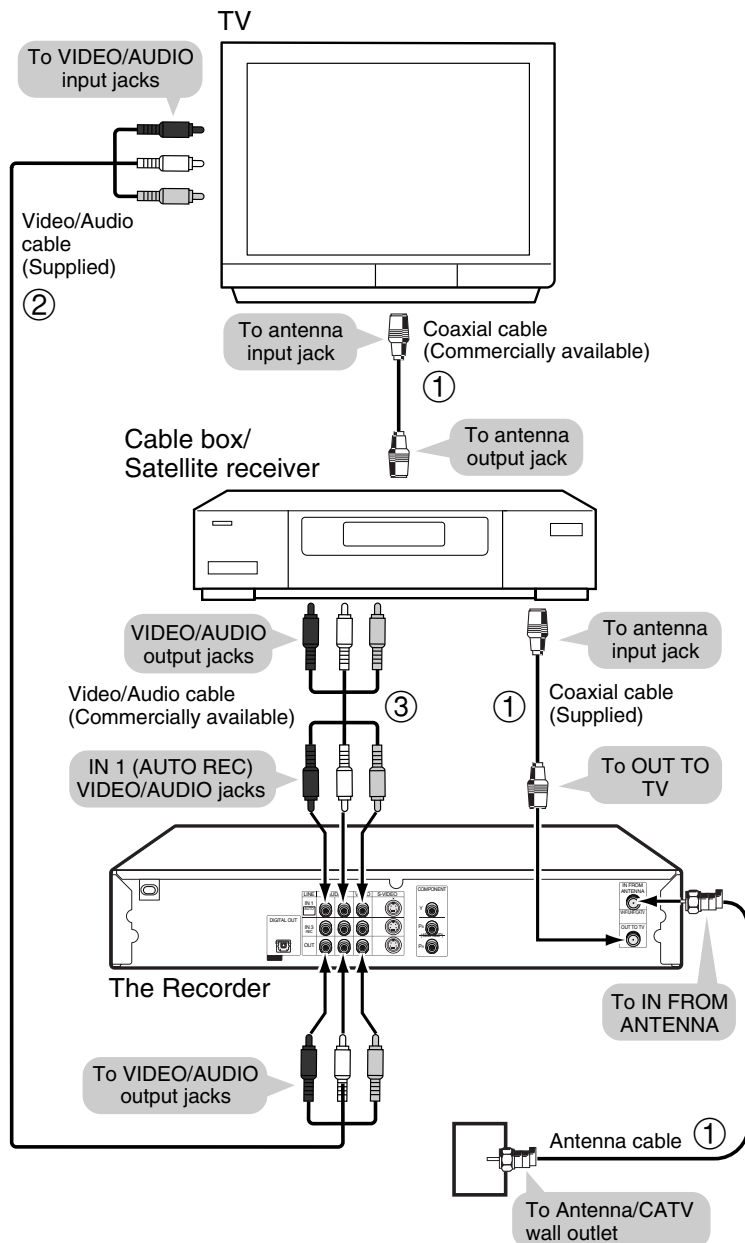

1 Connect the TV antenna and coaxial cables as shown on the left.

You can watch and record the TV channels.

NOTE

- The input signal to IN FROM ANTENNA jack is passed through to the OUT TO TV jack.

2 Connect the VIDEO/AUDIO output jacks on this recorder to the VIDEO/AUDIO input jacks on your TV using a Video/Audio cable.

You can watch discs.

3 Connect the VIDEO/AUDIO IN 1 jacks on this recorder to the VIDEO/AUDIO output jacks on your cable box or satellite receiver using a Video/Audio cable.

You can record scrambled CATV channels when using a cable box or satellite receiver for decoding.

NOTE

- This is a standard video connections. You can use S-Video or component connections if they are available.

! Important!

- Connect this recorder directly to your TV and not via the VCR, cable box or satellite receiver.
- When using this connection, set "PROGRESSIVE" in "PLAYBACK SETUP" to "OFF". (When the setting is "ON", the disc playback picture cannot be viewed.)

After the Connection

Plug in the power cords of the TV and cable box/satellite receiver. Then go to "EZ Set Up" (see page 23).

CATV or Satellite Receiver Connections

Connecting to a Cable Box or Satellite Receiver (2)

The following connection is the connection to a cable box or satellite receiver when receiving many or all the channels are scrambled.

Using this connection, you can:

- Record any CATV signals by selecting them the cable box or satellite receiver.
- Record using AV AUTO REC function.

NOTE

- In this connection, you cannot record another channel while you watch one channel.

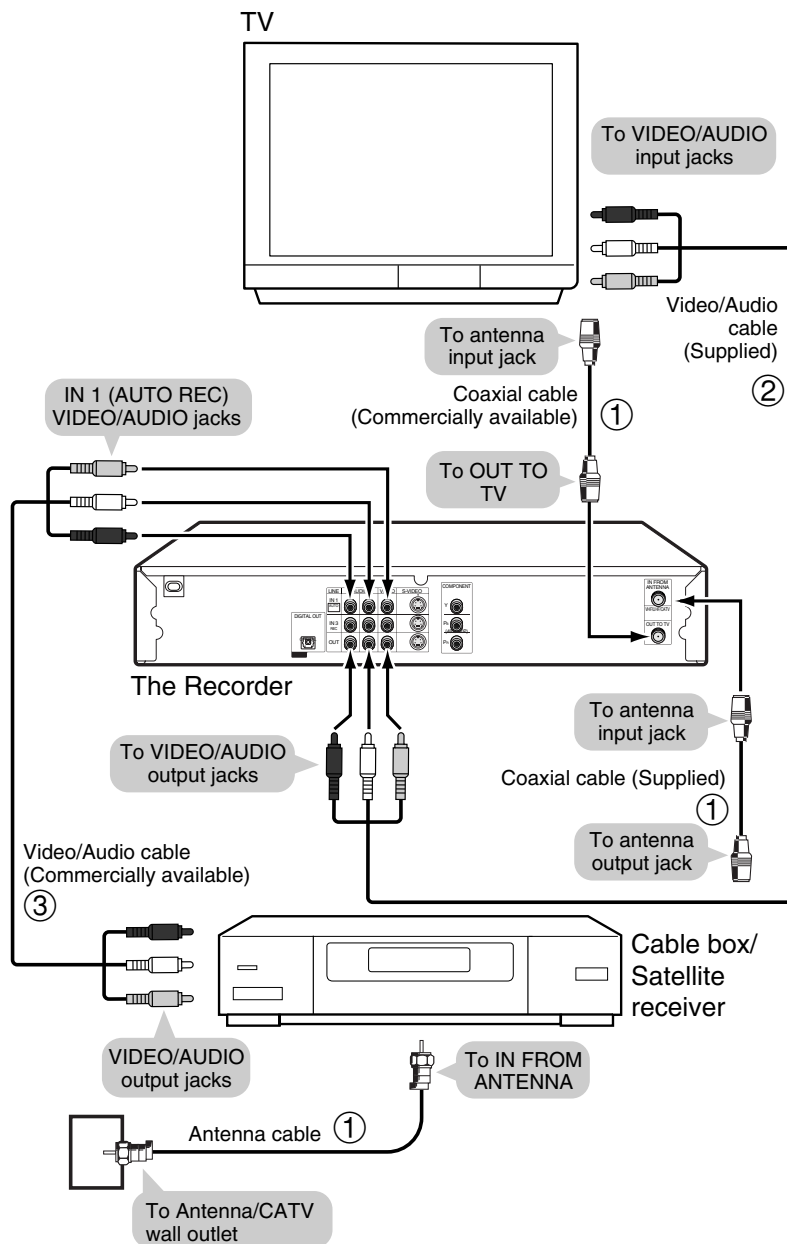

1 Connect the TV antenna and coaxial cables as shown on the left.

You can watch and record the TV channels.

NOTE

- The input signal to IN FROM ANTENNA jack is passed through to the OUT TO TV jack.

2 Connect the VIDEO/AUDIO output jacks on this recorder to the VIDEO/AUDIO input jacks on your TV using a Video/Audio cable.

You can watch discs.

3 Connect the VIDEO/AUDIO IN 1 jacks on this recorder to the VIDEO/AUDIO output jacks on your cable box or satellite receiver using a Video/Audio cable.

You can record scrambled CATV channels.

NOTE

- This is a standard video connections. You can use S-Video or component connections if they are available.

Important!

- Connect this recorder directly to your TV and not via the VCR, cable box or satellite receiver.
- When using this connection, set "PROGRESSIVE" in "PLAYBACK SETUP" to "OFF". (When the setting is "ON", the disc playback picture cannot be viewed.)

After the Connection

Plug in the power cords of the TV and cable box/satellite receiver. Then go to "EZ Set Up" (see page 23).

EZ Set Up

! Important! (Caution during EZ Set Up):

- Do not press **POWER** on the recorder or remote control.

The EZ Set Up function automatically sets the tuner channels and clock when the antenna cable is connected to the rear of the recorder and the power plug is then connected to an AC outlet.

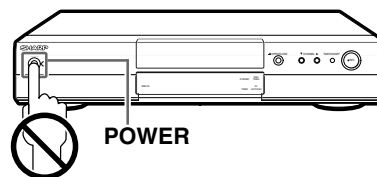

! Important!

When using a cable box:

- See "CATV or Satellite Receiver Connections" on page 21.
- Leave POWER on the cable box turned on and select a channel that carries EDS signals.

1 Make sure that the antenna cable is connected. For connection configuration, refer to "Basic Connection" on page 19.

2 Connect the power plug of the recorder to an AC outlet.

3 The tuner channels and clock will automatically be set.

- This recorder can monitor and use time-signals (EDS signals), which are provided by some TV stations, to automatically adjust the clock. This recorder automatically searches EDS signals, but if you are in a hurry to use timer recording or know the channel of the EDS signal carrier in your area, follow the procedure in "Auto Clock Setting" or "Manual Clock Setting".

During Auto Channel Setting

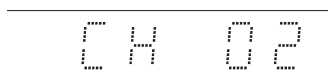

- Channel number is increasing.

During Auto Clock Setting

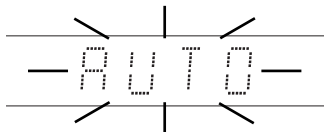

EZ Set Up complete

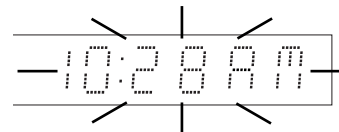

- Front Panel Display is turned off when setting "CLOCK DISP" in "OPTION SETUP" to "OFF".

NOTE

- If power is supplied to the recorder before the cable is connected, EZ Set Up will not be able to preset the channels into memory. If this occurs, press **RESET** in the front of the recorder (See page 101). EZ Set Up function will work again.
- If the power is turned on during EZ Set Up, the Auto Channel setting will be interrupted and the tuner channels will not be able to be preset.
- Auto Clock Setting may take several minutes.
- If the Auto Clock Setting is not completed within 30 minutes, there may be no channels with EDS signals. In this case, set the clock manually. (See "Manual Clock Setting" on page 26.)
- If the antenna signal is weak, the Auto Clock Setting function may not operate.
- During initial channel setting, the channels are set into the AIR channel setting. To watch CATV channel, select "CATV" on the CHANNEL PRESET screen. (See "Channel Setting" on page 24.)

Channel Setting

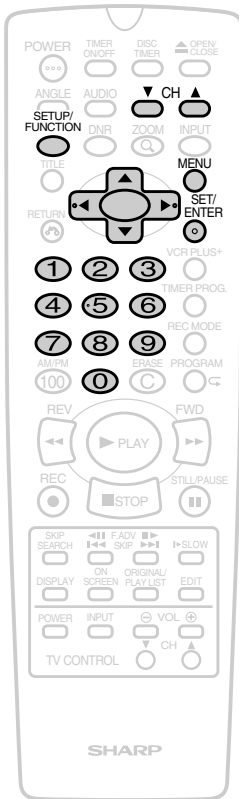

Channel Setting

This recorder can receive a maximum of 181 channels as shown below by presetting the channels into memory.
(VHF: 2 to 13, UHF: 14 to 69, CATV: 1 to 125)

! Important!

When you use the recorder for the first time, press **SETUP/FUNCTION**. "OSD LANGUAGE SETUP" screen appears. You should set the language to be used in the OSD. See "OSD Language Setting" on page 27 for details.

- 1 Press **SETUP/FUNCTION**.
Select "CHANNEL" with **▲ / ▼** and then press **SET/ENTER**.

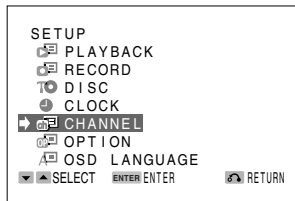

- 2 Press **◀ / ▶** to select "AIR" or "CATV" and then press **▼**.

Example: AIR

- To watch CATV after EZ Set Up, select "CATV", and then press **SET/ENTER**.

- 3 Press **◀ / ▶** to set "CH SET" to "AUTO" then press **SET/ENTER**.

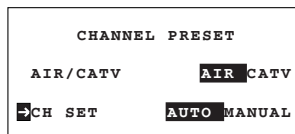

- 4 The automatic tuning will start.
 - The channel display will count up, and when finished, the screen returns to normal.

NOTE

- Automatic tuning will not start unless the arrow is at "CH SET-AUTO" position.
- If a button is not pressed within 3 minutes during the setting procedure, the screen will return to normal.
- If the power is interrupted for more than 1 hour, AIR / CATV selection must be set again.
- Automatic tuning will be interrupted if **SETUP/FUNCTION** is pressed before the screen returns to normal.

Adding Channel Memory/Erasing Channel Memory

Use this function to manually add or erase channels to/from the memory.

- 1 Select the channel to be added with the number buttons and the channel to be erased with the **CH ▲ / ▼** or number buttons.
- 2 Press **SETUP/FUNCTION**. The **MENU** screen appears. Press **▲ / ▼** to select "CHANNEL" and then press **SET/ENTER**.
- 3 Press **▲ / ▼** to select "CH SET" and then press **◀ / ▶** to select "MANUAL". Then press **SET/ENTER**.

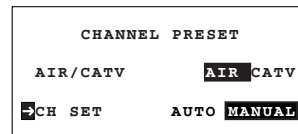

- 4 Press **◀ / ▶** to select "ADD" if you want to add the channel memory or "ERASE" if you want to erase the channel memory.

[ADD]

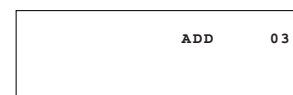

[ERASE]

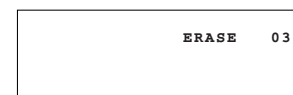

- 5 Press **RETURN** to return to the **CHANNEL PRESET** screen.

Clock Setting



Auto Clock Setting

(If you know a channel that carries EDS signals)

! Important!
When using a cable box:

- See "CATV or Satellite Receiver Connections" on page 21.
- Leave **POWER** on the cable box turned on and select a channel that carries EDS signals.

1 Press **SETUP/FUNCTION**. Press **▲ / ▼** to select "CLOCK" and then press **SET/ENTER**.

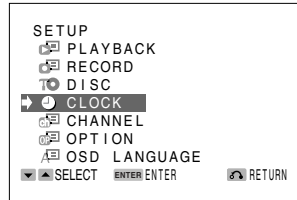

2 Press **▲ / ▼** to select "AUTO" and then press **SET/ENTER**.

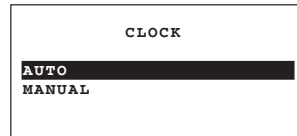

3 Press **◀ / ▶** to set EDS CH SET mode to "MANUAL" and then press **▼**.

4 Press **◀ / ▶** to select a channel that carries EDS signals and then press **▼**.

Example: 07

- The number of channels that can be selected depends on the mode setting on the CHANNEL PRESET screen. See **NOTE**.

When using a cable box:
Input the output channel (02, 03, or 04) of the cable box.

5 Press **◀ / ▶** to select "TIME ZONE".

- If you want the Recorder to use the time zone from which your broadcasts with EDS signals, choose **AUTO**. If your broadcasts with EDS signals from a different time zone than the one in which you live, be sure to select your time zone.

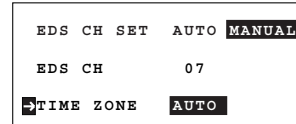

6 Press **SET/ENTER** to enter. The screen returns to normal.

7 Press **POWER** to turn off the recorder.

- The Auto Clock Setting function will automatically set the clock.

NOTE

- If the EDS CH SET mode is set to **MANUAL** mode in Step 3 and a channel that does not carry EDS signal is selected in Step 4, the Auto Clock Setting function will not operate.
- In Step 4, the number of channels that can be selected depends on the mode setting on the CHANNEL PRESET screen. See the table below.

AIR/CATV	Channels to be selected
AIR	02 ↔ 03 ↔ 04 68 ↔ 69 ↔ 02
CATV	01 ↔ 02 ↔ 03 124 ↔ 125 ↔ 01

- In Step 1, if you press **SETUP/FUNCTION** when operating the screen setting for the first time, the OSD LANGUAGE SETUP screen will appear.
- If you entered incorrect data during the setting procedure, re-enter the correct data in the following manner:
 - ① Use **◀ / ▶** to select the data to be corrected.
 - ② Set the correct data with **▲ / ▼**.
 - ③ After correcting the data in Step ②, press **SET/ENTER** to enter.
- If you press **RETURN** or **SETUP/FUNCTION** in Step 6, the data will not be stored.
- If a button is not pressed within 3 minutes during the setting procedure, the screen will return to the normal screen.
- "TIME ZONE" is changed as follows.

→ AUTO ↔ ATLANTIC ↔ EASTERN ↔ CENTRAL ↔
HAWAII ↔ ALASKA ↔ PACIFIC ↔ MOUNTAIN ←

Clock Setting



Manual Clock Setting

- 1 Press **SETUP/FUNCTION**. The **MENU** screen appears. Press **▲ / ▼** to select **"CLOCK"** and then press **SET/ENTER**.

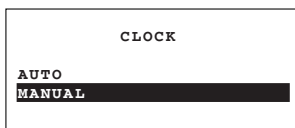

- 2 Press **▲ / ▼** to select **"MANUAL"** and then press **SET/ENTER**.
- 3 Press **◀ / ▶** to select **"TIME"** and press **▲ / ▼** to set time.

Example: 10:28 AM

- Number buttons can be used instead of **▲ / ▼** to set time and date. Press **AM/PM** to select AM or PM during time setting.

- 4 Select and set **"DATE"**, **"YEAR"** and **"DST"** in turn, in the same manner as in Step 3.

- See "Automatic Daylight Saving-Time (D.S.T.) Adjustment".

Example: Jul. 4, 2003, DST: ON

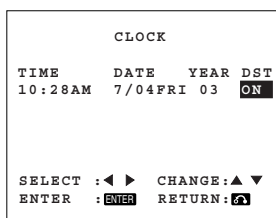

- 5 If the data is correct, press **SET/ENTER** to enter.

- The screen returns to normal.

NOTE

- If you entered incorrect data during the setting procedure, re-enter the correct data in the following manner:
 - ① Use **◀ / ▶** to select the data to be corrected.
 - ② Set the correct data with **▲ / ▼**.
 - ③ After correcting the data in Step ②, press **RETURN** or **SET/ENTER** to enter.
- If you press **RETURN** or **SETUP/FUNCTION** to exit the clock setting screen in Step 4, the data will not be stored.
- If a button is not pressed within 3 minutes during the setting procedure, the screen will return to the normal screen.

Automatic Daylight Saving-Time (D.S.T.) Adjustment

This recorder is equipped with an internal Automatic Daylight Saving-Time Adjustment function. In spring (first Sunday in April) and autumn (last Sunday in October), the time is adjusted as shown below. This function has been preset to ON at the factory. Set the D.S.T. mode in the clock setting screen.

Spring

Programmed timer recording set within this time frame (2:00 AM to 3:00 AM) will not be carried out.

First Sunday in April (D.S.T. is ON)

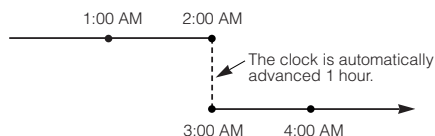

Autumn

Because there will be two time frames from 1:00 AM to 2:00 AM, timer programming set between these times will be influenced by the time change.

Last Sunday in October (D.S.T. is ON)

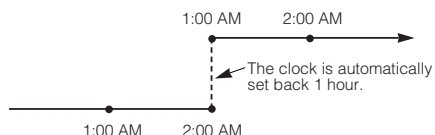

NOTE

- If the timer recording program is affected by the D.S.T. time change, check your TV listing and find out when it reflects the time change. Some TV listings will indicate the time change in the same manner as is programmed in this recorder, but others do not show the time change until the next morning. In that case, when programming a timer, use the clock setting screen to set the D.S.T. mode to OFF so the time change will not be carried out.

OSD Language Setting



1 Press **SETUP/FUNCTION** to display the MENU screen.

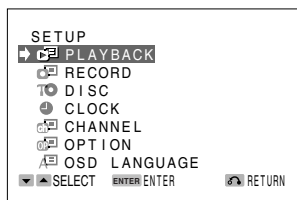

! Important!
When you use the recorder for the first time, press **SETUP/FUNCTION**. "OSD LANGUAGE SETUP" screen in the step **3** appears. You should set the language to be used in the OSD.

2 Press **▲ / ▼** to select "OSD LANGUAGE" and then press **SET/ENTER**.

3 Press **▲ / ▼** to select the language you want to use.
Example: **ENGLISH**

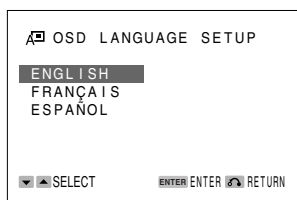

4 Press **SET/ENTER** to enter and then press **RETURN** to return to the **SETUP** screen.

NOTE

- If you press **RETURN** or **SETUP/FUNCTION** to exit the OSD LANGUAGE SETUP screen in Step **3**, the data will not be stored.

Display Information



Change the Display on the TV Screen

Each time **ON SCREEN** on the remote control unit is pressed, the display on the TV screen changes the mode in the following sequence:

→ **AUTO** → **ON** → **OFF**

(When the disc is set)

→ **AUTO** → **ON** → **OFF** → **Disc Information**

AUTO: Displays indicators for 3 seconds when operation begins.

ON: Displays indicators continuously until the operation mode is changed.

OFF: Does not display indicators.

Disc information: Displays the information on the disc when the disc is set. During playback, the information is displayed for about 10 seconds and automatically disappear.

■ Operation mode screen

Example:

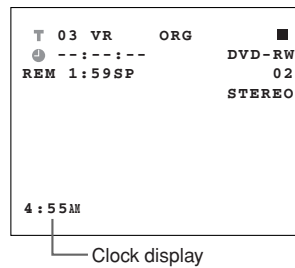

■ Disc information screen

Example:

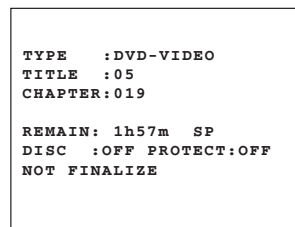

Change the Display on the Front Panel Display

Each time **DISPLAY** on the remote control unit is pressed, the Front Panel Display changes the mode in the following sequence:



STANDBY

- When the recorder is turned off (STANDBY indicator lights on), clock is displayed. The display goes off automatically after one minute (when setting "CLOCK DISP" in "OPTION SETUP" to "OFF").

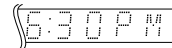

Example: During stop mode

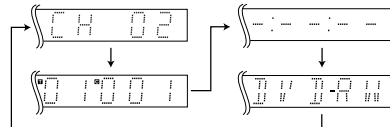

Example: When playing back the DVD-RW disc

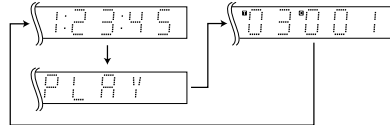

The time is not displayed when a disc is played back on which the time has not been recorded.

Example: When recording onto the DVD-RW disc

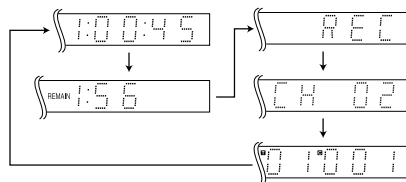

NOTE

- This recorder turns off the clock indicator on the Front Panel Display to save electricity when the product is turned off. To display the clock indicator during power off, set "CLOCK DISP" in "OPTION SETUP" to "ON" (See page 90).

Playback



DVD Playback

Playback the playback-only discs

DVD VIDEO

1 Turn on the TV and switch the TV channel to the external “VIDEO” or “AV” channel connected to the VIDEO/AUDIO output jacks.

2 Press **POWER**. The recorder is turned on.

3 Press **OPEN/CLOSE** to open the disc tray.

4 Load a disc onto the tray.

- Position it with the printed title side facing up, align it with the guides.
- When you load a double-sided disc, load it with the side you want to play face down.

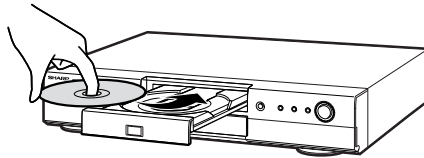

5 Press **OPEN/CLOSE** to close the disc tray.

- When the disc is being identified (“LOAD” is displayed on the Front Panel Display), the DISC IN indicator on the front panel is blinking. The indicator lights when the disc is finished being identified (“LOAD” disappears).
- Some discs start playback automatically.

6 Press **▶PLAY** to start playback.

- If you’re playing some DVD-Video discs, a disc menu screen may appear. See page 45 for how to operate the menu.

7 Press **■STOP** to stop playback.

- When starting playback from the place last stopped, go to step **8**.
- When starting playback from the beginning, go to step **9**.

Resume Function

This recorder stores the location where you stopped the disc. This function enables you to resume the playback from the place last stopped.

8 Press **▶PLAY** after pressing **■STOP** in the step 7.

- Play resumes from a point slightly before the point where it was stopped.
- Resume information will not be canceled if the power is turned off.
- Resume function may not work on some discs.



NOTE

The resume function is canceled in the following cases.

- When you press **■STOP** during auto-playback.
- When you open the disc tray.
- When you display the DiscNavi screen.
- When a DVD-R/RW disc has been edited or finalized after playback has been stopped.
- When you switch between ORIGINAL and PLAYLIST.

Playback From the Beginning

9 Press **■STOP** again.

10 Press **▶PLAY**.

NOTE

- When taking out a disc, first press **■STOP** before taking out the disc. When the **OPEN/CLOSE** is pressed during playback, it may take a short time for the tray to open.
- In cases when a disc cannot be played back as a result of inserting a non-standard disc or the presence of scratches and so forth on the disc “INCORRECT TYPE. REMOVE DISC.” will appear and all other functions of the recorder will be disabled except for opening and closing of the tray. Take out the disc when this happens.

Playback



Selected Title Playback

DVD VIDEO

- 1** Press **ZOOM** during stop mode.
- 2** Press number buttons to enter the title number.
- 3** Press **SET/ENTER**.
 - Selected title is played back.

NOTE

- This function does not work or work correctly on some discs.

Recorded DVD Disc Playback

DVD RW | DVD RW | DVD R
VR MODE | VIDEO MODE

- When playing back DVD-R or DVD-RW discs recorded with this recorder, first select the title where you want to start playback.
- Select a title by displaying a list of first scenes for each title (DiscNavi).

Playback After Confirming Contents with DiscNavi

DiscNavi displays a list of the first scene of each title.

NOTE

- When the DV input is selected, discs cannot be played back if "DV LINK" is set to "ON". You can enjoy other channels by switching to the other channel.

- 1** Load a disc recorded in VR mode.

- 2** Press **TITLE** or **MENU**.

- DiscNavi Title List screen appears.

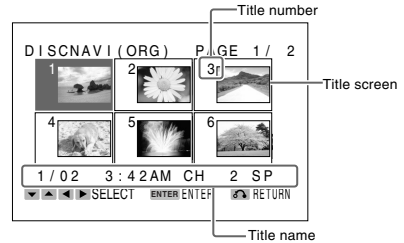

- If a DVD-RW disc (VR mode) has the PLAYLIST, you can switch the screens between PLAYLIST and ORIGINAL by pressing **ORIGINAL/PLAYLIST**.

- 3** Press **▲/▼/◀/▶** to select the title screen you want to watch.

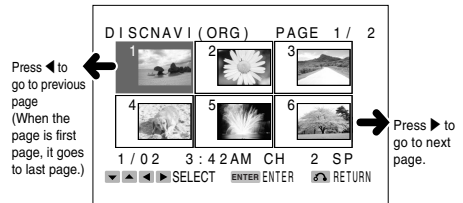

- 4** Press **SET/ENTER**.

- Selected title is played back.

NOTE

- Parts that have been erased (page 65), moved (page 75) or added (page 76) during editing appear as a momentarily paused during playback.
- In the case of titles added with another DVD recorder that contain characters which cannot be displayed with this recorder, the titles are displayed as "*****" (up to a maximum of 24 characters).
- Titles for which recording has been interrupted due to a scratched disc, soiled disc or other reason are displayed with an exclamation point "!" in front of the title displayed on the DiscNavi menu and so forth.
- When playing back the playlist of a disc that has been edited with another DVD recorder, and a single title lasts for 12 hours or more, that title cannot be played back beyond 12 hours.
- Discs edited with another DVD recorder that contain more than 201 chapter markers cannot be played back.



Playback

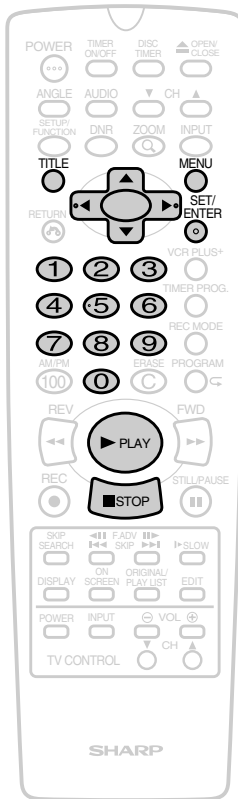

Playback by Selecting a Title

When playing back a disc recorded in the Video mode after it has been finalized, play back the disc by selecting a title after displaying the list of titles by pressing **MENU**.

NOTE

- This function can be used for DVD-R or DVD-RW Video mode disc that have been finalized.

1 Load a disc recorded in Video mode.

2 Press **TITLE** or **MENU**.

- Title screen appears.

After Finalize

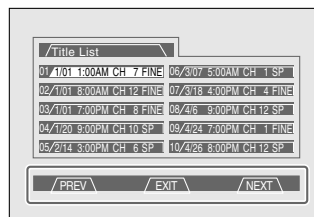

NOTE

- When a disc that has been recorded in the Video mode is finalized (pages 12 and 88), a menu is automatically created that can be played back even with other DVD players. Consequently, the menu before finalizing is different from that of after finalizing.
- In the case of titles added with another DVD recorder that contain characters which cannot be displayed with this recorder, the titles are displayed as "*****" (up to a maximum of 24 characters).

3 Press **▲/▼/◀/▶** to select the title name.

4 Press **SET/ENTER**.

- Selected title is played back.

Video CD/Audio CD/CD-R/CD-RW Playback

VIDEO CD AUDIO CD CD-R CD-RW

1 Load a CD and press **▶PLAY**.

2 Press **■STOP** to stop the playback.

Selected Track Playback

VIDEO CD AUDIO CD CD-R CD-RW

1 Press number buttons to select the track number during playback.

Example: For track 12, press 1,2.

2 Press **SET/ENTER** or **▶PLAY**.

- Selected track (music) is played back.

Playing VIDEO CDs with Playback Control (PBC)

- Pressing **▶PLAY** begins PBC playback. Time display is not shown for some discs.
- If you specify the track number to be played (with playback stopped) and press **▶PLAY**, normal playback (not PBC playback) begins.

Digital Connection to an MD to Record a CD

When you are using a digital connection to record the contents of a CD to an MD, the track numbers of the CD may not match the track numbers recorded to the MD.

NOTE

- When the DV input is selected, discs cannot be played back if "DV LINK" is set to "ON". You can enjoy other channels by switching to the other channel.

Playback

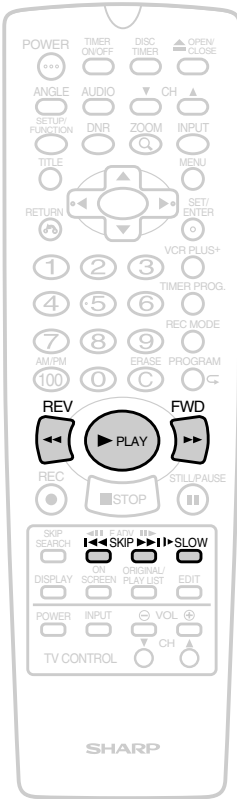

Fast Forward/Fast Reverse

DVD VIDEO DVD RW DVD RW DVD R VIDEO CD
AUDIO CD VR MODE VIDEO MODE

Press **FWD** or **REV** during playback.

- The disc begins fast scan at x2 speed (1).

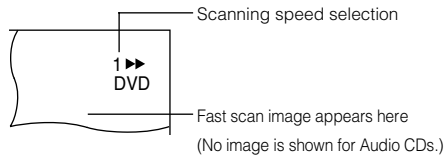

- Three speeds are available for DVD and two speeds for CD. Each time **FWD** or **REV** is pressed, the speed of fast scan changes in the following sequence:

(DVD) → 1 (about x2) → 2 (about x8) → 3 (about x32)

(Video CD and Audio CD)

→ 1 (about x2) → 2 (about x8)

Fast Forward/Fast Reverse (Search) Function on the Recorder

Press and hold **SKIP** for more than 2 seconds on the front of the recorder.

- The search speed is 2 (about x8).

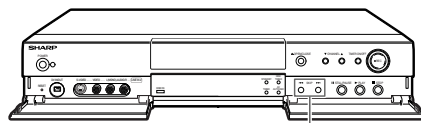

NOTE

- On some discs, the fast scan function is disabled.
- On DVD discs and Video CDs, audio and subtitles are not played back during the fast scan playback.
- With a DVD disc, you cannot search past a title. Playback starts from the beginning of the title.
- During the fast scan playback, the sound may not come out.
- When the fast forward search function is used during playback of a DVD video disc, the speed may differ from that described in this manual depending on the disc and the scene being played back.

SKIP (Forward/Reverse)

DVD VIDEO DVD RW DVD RW DVD R VIDEO CD
AUDIO CD VR MODE VIDEO MODE

While you are playing a disc, this function jumps to the beginning of the next chapter/track (Forward) or the current chapter/track (Reverse) and automatically starts playing that chapter/track.

Press **SKIP** or **SKIP** during playback.

- Playback skips forward one chapter/track for each time **SKIP** is pressed.
- If you press **SKIP** and playback begins, and you then press **SKIP** again within 5 seconds, playback returns to the beginning of the previous chapter/track.

NOTE

- On some discs, the skip functions are disabled.

Slow-Motion

DVD VIDEO DVD RW DVD RW DVD R VIDEO CD
VR MODE VIDEO MODE

1 Press **SLOW** during playback.

- Three speeds are available. Each time **SLOW** is pressed, the speed of slow-motion playback changes in the following sequence:

→ 1 (about x1/2) → 2 (about x1/8) → 3 (about x1/16)

2 Press **PLAY** to return to the normal playback.

NOTE

- On some discs, the slow-motion playback functions are disabled.



Playback



Still/Pause Frame Advance

DVD VIDEO | DVD RW | DVD RW | DVD R | VIDEO CD
VR MODE | VIDEO MODE

1 Press **|| STILL/PAUSE** during playback.

- The playback is stilled.
- The playback is paused when Audio CD is played back.

2 Press **F.ADV** or **◀ F.ADV**.

- The disc goes forward by one frame each time **F.ADV** is pressed.
- The disc goes rewind by one frame each time **◀ F.ADV** is pressed.
- If you press and hold **SKIP▶▶** for more than 2 seconds on the front of the recorder, search will be started.

3 Press **▶ PLAY** to return to the normal playback.

NOTE

- On some discs, still/pause and frame advance functions are disabled.
- The frame advance playback functions are disabled for Audio CDs.
- The frame reverse playback function is disabled for Video CDs.
- Picture quality may diminish during frame advance and frame reverse with a disc other than a DVD-RW disc in VR mode (such as a DVD video disc).

Skip Search

DVD VIDEO | DVD RW | DVD RW | DVD R
VR MODE | VIDEO MODE

With this feature, you can set a forward search time to approx. 30, 60, 90 or 120 seconds of recorded material. After searching, normal playback will resume automatically.

- Press **SKIP SEARCH** during playback. (Example: during commercials)

Number of Times Pressed	Search Time
1 Time	Approx. 30 sec.
2 Times	Approx. 60 sec.
3 Times	Approx. 90 sec.
4 Times	Approx. 120 sec.

NOTE

- This function can only be used within the same title.

MP3 Discs Playback

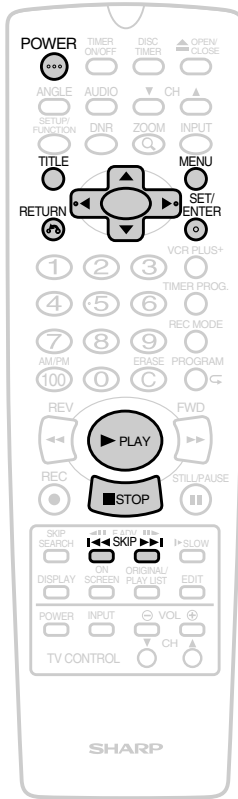

CD-R CD-RW

NOTE

- When the DV input is selected, discs cannot be played back if "DV LINK" is set to "ON". You can enjoy other channels by switching to the other channel.
- See page 8 for details about the MP3 file format.

- 1 Press POWER.** The recorder is turned on.
- 2 Load the MP3 recorded CD-R or the CD-RW and then press TITLE or MENU.**

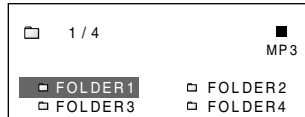

- 3 Press ▲/▼/◀/▶ to select the folder you want to play and then press SET/ENTER.**
 - The file (music title) in the folder is displayed on the file selection screen.

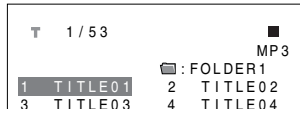

- 4 Press ▲/▼/◀/▶ to select the file (music title) you want to play and then press SET/ENTER.**
 - The chosen file (music title) will be played in sequence.

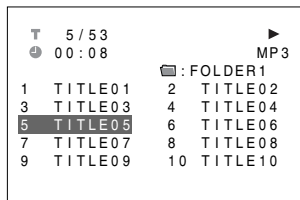

- 5 Press ■STOP to stop play.**

To Play Another File (music title) during Playback

Press ▲/▼/◀/▶ to select the file (music title) you want to play and then press SET/ENTER.

- The chosen file (music title) will be played.

NOTE

- The file where the cursor is on will be played when the cursor is moved to a different from the file being played and no operation is taken within 10 seconds.

To Skip the File during Playback

Press SKIP▶▶I or I◀◀SKIP.

- SKIP▶▶I will skip forward, and I◀◀SKIP will rewind.

While the MP3 disc is playing

- Time Search is disabled.
- Programmed playback is disabled.
- It is possible to repeat one track or the entire folder.
- Dolby Virtual Surround does not operate.

Changing Image/Audio During Playback

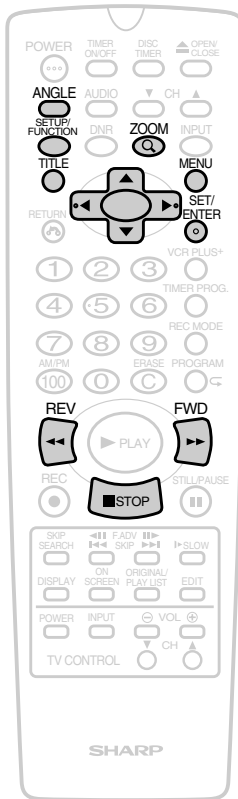

Zoom Function

You can zoom the desired part of an image during DVD playback.

DVD VIDEO | **DVD RW** | **DVD RW** | **DVD R**
VR MODE VIDEO MODE

1 Press **ZOOM** during playback.

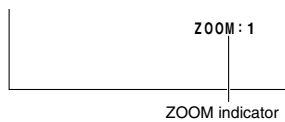

- Each press of **ZOOM** cycles through the zoom settings in the following sequence:

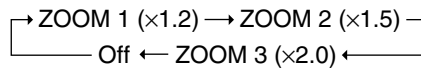

2 While an image is zoomed, press **▲/▼/◀/▶** to shift the view and display the part you want.

The ZOOM indicator changes from white to red to let you know when you are trying to perform an illegal shift of view.

3 Press **ZOOM** to return to the normal screen

NOTE

- An image may become distorted when zoomed.
- You can cancel the zoom operation by pressing **FWD▶▶**, **◀◀REV**, **TITLE**, **MENU**, **SETUP/FUNCTION** or **STOP**.
- The zoom operation is cleared automatically whenever you display a DVD screen that enables you to change the scene by pressing **▲/▼/◀/▶**.
- Subtitle cannot be zoomed.

Angle Function

DVD VIDEO

You can change the angle of view when playing a DVD video disc that contains scenes recorded from multiple angles.

1 Press **ANGLE** during playback.

- mark lights when different angles are recorded for the title currently playing.
- Show the number of the current angle.



- If no angles are recorded on the disc, xx is displayed.

2 Press **▲/▼** (or **ANGLE**) to change the scene to the next angle in those recorded.

- About 10 seconds later, the indicator on the TV will disappear automatically. (Or press **SET/ENTER** to turn off the indicator.)

NOTE

- The operation differs depending on the discs. Refer to the operation manuals for your disc.

Changing Image/Audio During Playback

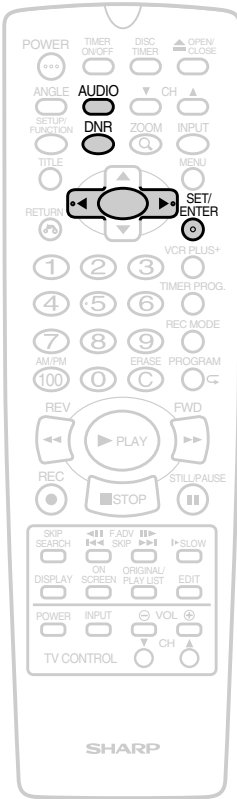

Audio Setting

DVD RW | VIDEO CD | AUDIO CD

VR MODE
You can change the audio output channel between stereo, left channel and right channel when you play Video CDs and Audio CDs. You can change the audio output channel when you play a DVD-RW disc recorded multiple sounds in VR mode (See also page 87).

Each time **AUDIO** is pressed, the audio channels changes as follows:

VIDEO CD | AUDIO CD

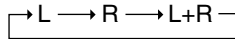

DVD RW | VR MODE

It may differs depending on the recorded sound on the disc. See the table of SAP on page 87 for details.

NOTE

- When you play a VR mode disc recorded on a Dual Mono, and if you are listening to the Dolby Digital sound via the digital output jack, you cannot select the audio channel. Set "Digital OUT" in "PLAYBACK SETUP" to "PCM" (See page 81), or if you want to change the audio channel, listen via the analog output jacks.

Monitor Output when Receiving a Stereo or SAP Broadcast

When receiving a stereo or SAP broadcast, press **AUDIO** to change the audio output mode to select Monitor Output. See the table of SAP on page 87 for details.

NOTE

- When the signal is weak (it is hard to listen) in a stereo broadcast, press **AUDIO** to turn off "L R" display on the TV screen and change the audio output mode to MONO.

DNR (Digital Noise Reduction)

DVD VIDEO | DVD RW | DVD RW | DVD R | VIDEO CD

When the noise contained in recorded material being played back becomes a problem, you can reduce the noise to make the picture clearer. DNR can be set to one of three levels according to the recorded material being played back. It is recommended to turn DNR "ON" when playing back discs that have been recorded in the LP mode or EP mode, and turn DNR "OFF" when playing back discs having low noise levels such as DVD video discs.

1 Press DNR during playback.

- Each time **DNR** is pressed, the mode changes between "ON" and "OFF".



2 When the mode is "ON", press ◀/▶ to adjust the level.

- Effects are diminished when ◀ is pressed.
- Effects are enhanced when ▶ is pressed.

NOTE

- About 10 seconds later, the indicator on the TV will disappear automatically. (Or press **SET/ENTER** to turn off the indicator.)
- The DNR function does not work when setting "PROGRESSIVE" in "PLAYBACK SETUP" to "ON".

Programmed Playback

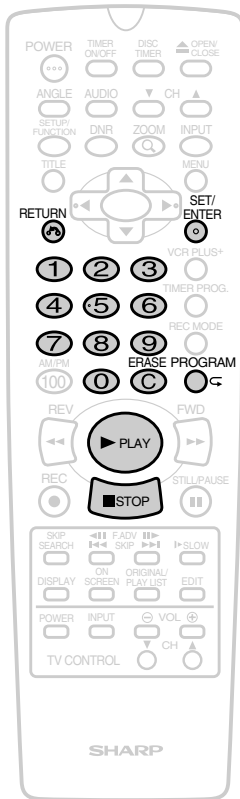

Title/Track Programmed Playback

DVD VIDEO | DVD RW | DVD R | VIDEO CD | AUDIO CD
VIDEO MODE

1 Press **PROGRAM** while the disc is stopped.

- The "TITLE PROGRAM" screen appears.

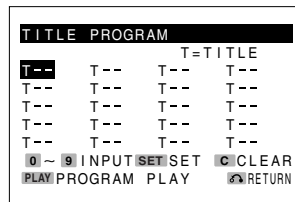

- Each time **PROGRAM** is pressed, the mode changes between "Title (Track) Program" and "Chapter Program".
- Press **RETURN** to return to normal screen.
- Chapter Program does not work on Video CDs and Audio CDs.
- Track Program screen is displayed when a Video CD or Audio CD is set.

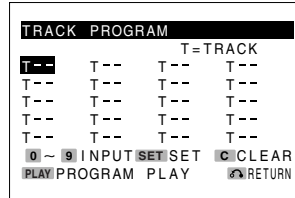

2 Press number buttons to enter the desired title number and then press **SET/ENTER**.

Example:

- For title 10, press 1, 0 and then press **SET/ENTER**.
- For title 2, press 2 and then press **SET/ENTER**.

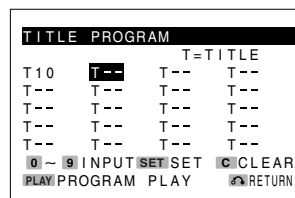

- Repeat step 2 to program other titles.

NOTE

- Up to 20 titles can be programmed.
- When you input the title number which has not been recorded on the disc, the number is not set. Input correct title number.
- Press **ERASE** to cancel the program.
- Press and hold **ERASE** for about 2 seconds, all programmed title is canceled.

3 Press **▶PLAY**.

- The title will be played in the order they were entered.

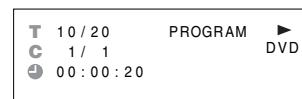

4 Press **■STOP** to stop the programmed playback.

- To start programmed playback again, repeat step 1 to 3.

NOTE

- The program cannot be set during playback.
- This function can only be used for discs on which the title has been recorded.
- On some discs in which programmed playback is prohibited, this function is disabled.
- Programmed playback does not work on DVD-RW discs in VR mode.

Programmed Playback

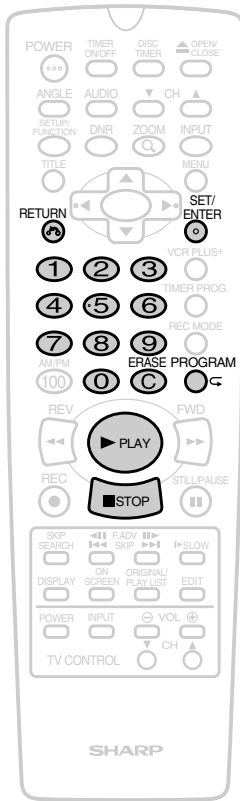

Chapter Programmed Playback

DVD VIDEO | DVD RW | DVD R
VIDEO MODE

1 Press PROGRAM twice while the disc is stopped.

- The "CHAPTER PROGRAM" screen appears.

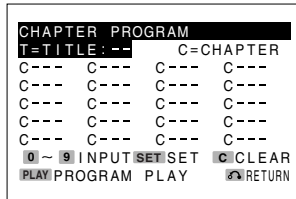

- Press RETURN to return to normal screen.

2 Press number buttons to enter the desired title number and then press SET/ENTER.

Example:

- For title 10, press 1, 0 and then press SET/ENTER.
- For title 2, press 2 and then press SET/ENTER.

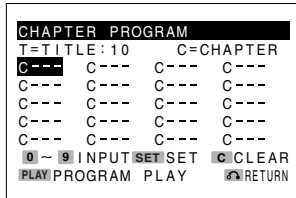

3 Press number buttons to enter the desired chapter number and then press SET/ENTER.

Example:

- For chapter 10, press 1, 0 and then press SET/ENTER.
- For chapter 2, press 2 and then press SET/ENTER.

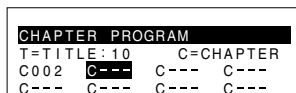

- Repeat step 3 to program other chapters.

NOTE

- Up to 20 chapters can be programmed.
- When you input the chapter number which has not been recorded on the disc, the number is not set. Input correct chapter number.
- Press ERASE to cancel the program.
- Press and hold ERASE for about 2 seconds, all programmed chapter is canceled.
- Press RETURN to cancel the setting

4 Press PLAY.

- The chapter will be played in the order they were entered.

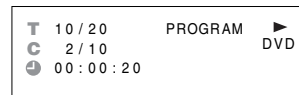

5 Press STOP to stop the programmed playback.

- To start programmed playback again, repeat step 1 to 3.

NOTE

- The program cannot be set during playback.
- This function can only be used for discs on which the chapter has been recorded.
- This function does not work on Video CDs or Audio CDs.
- On some discs in which programmed playback is prohibited, this function is disabled.

Repeat Playback



Repeat Playback

1 Press **REPEAT** while a disc is playing.

- Each time **REPEAT** is pressed, the repeat function changes as follows.
- Depending on the disc type, the repeat function will vary.

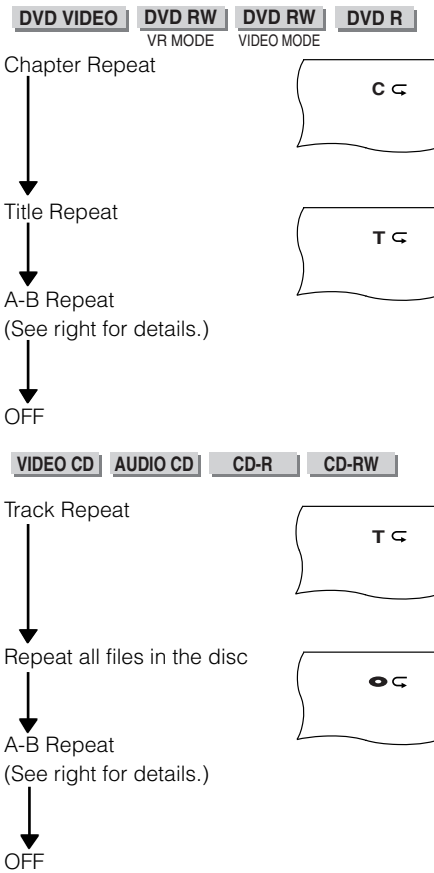

2 Press **SET/ENTER** or **PLAY** to start repeat playback.

- Press **REPEAT** and select OFF to return to the normal playback.

NOTE

- Repeat playback is disabled on some discs.
- Repeat playback cannot be used during programmed playback.
- Repeat playback cannot be used on Video CDs with PBC mode playback.

A-B Repeat Playback

DVD VIDEO **DVD RW** **DVD RW** **DVD R** **VIDEO CD**
AUDIO CD
 VR MODE VIDEO MODE

A-B repeat allows you to repeat specified section on the disc.

1 Press **REPEAT** three times while a disc is playing.

2 While you are playing a disc, press **SET/ENTER** or **PLAY** when you reach the start of the section to be repeated.

3 While the disc is playing the same chapter/track, press **SET/ENTER** or **PLAY** again when you reach the end of the section to be repeated.

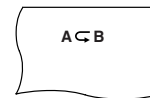

- The A-B repeat begins from the point where you specified in step 2.

4 Press **REPEAT** to return to the normal playback.

NOTE

- To cancel A-B repeat, press **STOP**, **TITLE**, **MENU** or other buttons.
- A-B repeat can only be used within the same title/track.
 (On some DVD discs, A-B repeat is restricted to the same chapter.)
 If the title/track finishes before specifying the ending location (B), the location where the title/track finishes will be set as the ending location (B).
- The A-B repeat function cannot be used during programmed playback.
- The A-B repeat function does not operate in scenes where different camera angles are recorded.
- The A-B repeat cannot be used on Video CDs with PBC mode playback.

Function Control

While the disc is playing, press **SETUP/FUNCTION** to display the screen shown below. Using Function control, you can check at a glance and change the current settings of the each items.

Example: DVD video disc

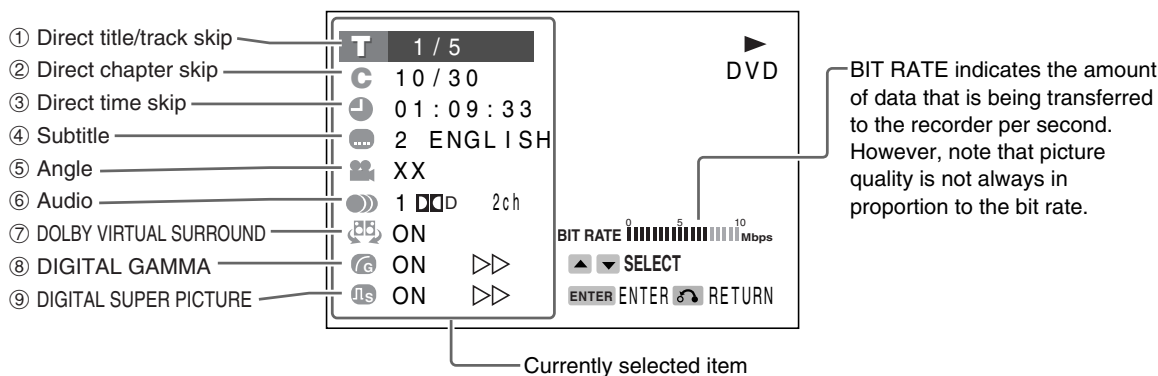

① **T** Direct title/track skip (P.41)

- The number of the title/track (max. 99) currently played back is displayed.
- You can skip directly to the desired title/track.
- When a disc with no title is played back, XX is displayed.

② **C** Direct chapter skip (P.41)

- The number of the chapter (max.999) currently played back is displayed.
- You can skip directly to the desired chapter.
- When a disc with no chapter is played back, XX is displayed.

③ **⌚** Direct time skip (P.41)

- Elapsed time from the beginning of the disc is displayed.
- DVD discs Displays the elapsed time of the title.
CD Displays the elapsed time of the track.

④ **...** Subtitle setting (P.42)

- You can select the desired subtitle language if the disc has a number of different subtitle languages.
- The subtitle number and language currently selected are displayed. (When a disc with no subtitle is played back, xx is displayed.)

⑤ **👤** Angle setting (P.42)

- You can select the desired angle if the disc has a number of different angles.
- The current angle is displayed. (When a disc with only one angle is played back, XX is displayed.)

NOTE

- If the function control screen is displayed during playback of a DVD video disc, it may not be possible to perform the operations instructed by the DVD video disc. If this happens, perform the instructed operations after canceling the function control screen.

⑥ **🔊** Audio setting (P.42)

- The type of audio currently selected is displayed.
- You can select the desired type of audio.

⑦ **🔊** DOLBY VIRTUAL SURROUND setting (P.43)

- This function provides rich surround sound by stereo (2-channel audio) or TV.
- You can toggle the setting between "ON" and "OFF".

⑧ **G** DIGITAL GAMMA setting (P.43)

- You can make the entire image easier to see by brightening the darker and obscure portions.
- You can toggle the setting between "AUTO", "ON" and "OFF", and change the level.
- This function does not work when "PROGRESSIVE" in "PLAYBACK SETUP" to "ON".

⑨ **🖼️** DIGITAL SUPER PICTURE setting (P.43)

- This function enhances the fine detail of the image and outlines of the objects it contains by reducing the amount of picture noise.
- You can toggle the setting between "ON" and "OFF" and change the level.
- This function does not work when "PROGRESSIVE" in "PLAYBACK SETUP" to "ON".



Function Control

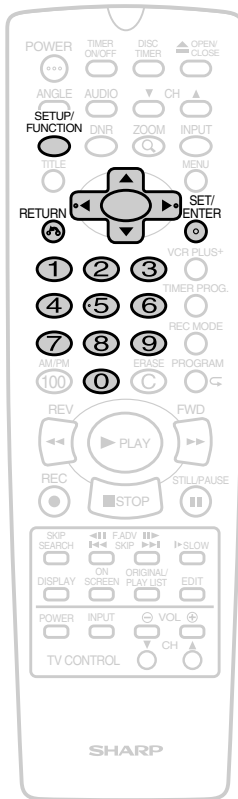

Direct Skip (title/chapter/track)

DVD VIDEO DVD RW DVD RW DVD R VIDEO CD
AUDIO CD
VR MODE VIDEO MODE

Use the following procedure to perform the Direct title [track] skip or Direct chapter skip.

1 Press **SETUP/FUNCTION** during playback.

- The Function control screen appears.

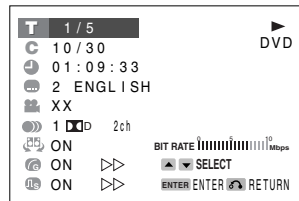

2 Press **▲/▼** to select **T** and then press **SET/ENTER**.

Example: Direct title skip



3 Press **▲/▼** to input the title number to which you want to skip.

- You can also number buttons to input the title number.
- Press **RETURN** to return to the previous screen.

Example: Entering title 5

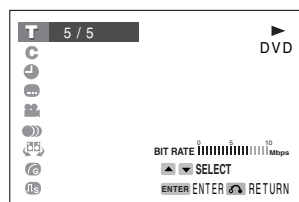

4 Press **SET/ENTER** to confirm the setting.

- The played back image changes to the beginning of the specified title.
- You can go on to specify other settings.

5 Press **SETUP/FUNCTION** or **RETURN** to return to normal playback screen.

NOTE

- On some discs, this function is disabled.
- This function does not work during programmed playback.

Direct Time Skip

DVD VIDEO DVD RW DVD RW DVD R VIDEO CD
AUDIO CD
VR MODE VIDEO MODE

You can play back from an intermediate location of a title or chapter by specifying the time.

1 Press **SETUP/FUNCTION** during playback.

- The Function control screen appears.

2 Press **▲/▼** to select **C** and then press **SET/ENTER**.

3 Press **▲/▼** to set "hour" and then press **▶**.

- Set "minutes" and "seconds" in the same way.
- If you enter the wrong number, press **◀** to return to the previous digit.
- Number buttons can be used instead of **▲/▼** to set.
- Press **RETURN** to return to the previous screen.



4 Press **SET/ENTER**.

- The played back starts from the specified time.
- You can intend to go on and specify other settings.

5 Press **SETUP/FUNCTION** or **RETURN** to return to the normal playback screen.

NOTE

- On Video CDs or Audio CDs, direct time skip can be set within the same track.
- On some discs, direct time skip is prohibited.
- This function does not work during programmed playback.



Function Control



Subtitle/Angle/Audio Setting

DVD VIDEO

Use the following procedure to perform the Subtitle language, Angle or Audio setting.

1 Press **SETUP/FUNCTION** during playback.

- The Function control screen appears.

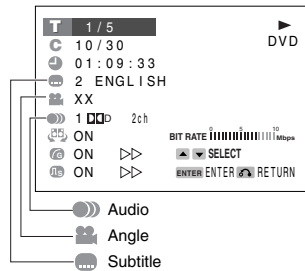

2 Press **▲/▼** to select **...** and then press **SET/ENTER**.

Example: Subtitle language setting



3 Press **▲/▼** to select the subtitle language you want to choose.

- Press **RETURN** to return to the previous screen.

4 Press **SET/ENTER** to confirm the setting.

- You can go on to specify other settings.

5 Press **SETUP/FUNCTION** or **RETURN** to return to the normal playback screen.

NOTE

About the subtitle setting

- When setting the subtitle language, you can also toggle the setting between “ON” and “OFF” by pressing **◀/▶**.

About the Audio setting

- With certain types of discs, you can change the audio using the disc menu.
- About the audio settings, see page 36 for details.
- On Video CDs and Audio CDs, audio is changed as follow:



- A DTS digital surround decoder is required to listen to DTS audio. (When use a DTS digital surround decoder, press **AUDIO** to select “DTS”.)



Function Control

Clearer Picture and Dynamic Sound Setting

DVD VIDEO DVD RW DVD RW DVD R VIDEO CD
VR MODE VIDEO MODE

DOLBY VIRTUAL SURROUND

- This function allows you to enjoy a “surround sound” effect when you are using an analog connection to 2-channel audio equipment (TV, etc.).
- The Dolby Virtual Surround feature is activated in the following cases even if digital equipment is connected.
 - When playing back the linear PCM audio of a DVD video disc.
 - When Dolby digital audio is played back when “ Digital OUT” has been set to “PCM” (See page 81).
- The Dolby Virtual Surround feature of this recorder employs the Spatializer system*.

* Certain audio features of this product manufactured under a license from Desper Products, Inc. Spatializer® N-2-2™ and the circle-in-square device are trademarks owned by Desper Products, Inc.

NOTE

- When a monaural audio recording is played back with the Dolby Virtual Surround feature “ON”, the sound level may be low and it may be difficult to hear. When this happens, turn the Dolby Virtual Surround feature “OFF”.
- The Dolby Virtual Surround feature does not function in the following cases:
 - When the Dolby Digital output level is set to “OFF”.
 - During TV broadcasts and external input
 - When playing back a Video CD or Audio CD
- When playing back discs or audio recordings for which the Dolby Virtual Surround features does not function, the Dolby Virtual Surround feature is automatically switched to “OFF”.
- There is no “Auto” setting.
- There is no level setting.

DIGITAL GAMMA

DIGITAL GAMMA is a digital image quality enhancement function that gives a richer image by brightening the darker and more obscure portions of the image without altering the brightness of the brighter portions, thereby making the entire image easier to see.

NOTE

- Three digital GAMMA level settings are available.
- When setting is “AUTO”, GAMMA level is set automatically depending on the brightness of the image.
- This function does not work during progressive playback.

DIGITAL SUPER PICTURE

DIGITAL SUPER PICTURE is a digital image quality enhancement function that gives a clearer image by sharpening the details and outlines in the image and reducing the amount of picture noise.

NOTE

- Three DIGITAL SUPER PICTURE level settings are available.
- There is no “Auto” setting.
- This function does not work during progressive playback.

Function Control



DOLBY VIRTUAL SURROUND/DIGITAL GAMMA/DIGITAL SUPER PICTURE setting

DVD VIDEO DVD RW VR MODE DVD RW VIDEO MODE DVD R VIDEO CD

Use the following procedure to perform the DOLBY VIRTUAL SURROUND, DIGITAL GAMMA or DIGITAL SUPER PICTURE setting

Example: Setting "DIGITAL GAMMA"

1 Press **SETUP/FUNCTION** during playback.

- The Function control screen appears.

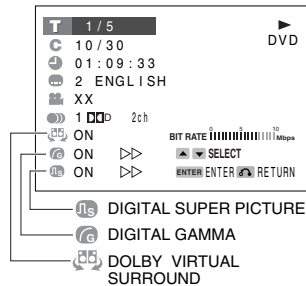

2 Press **▲ / ▼** to select **G** and then press **SET/ENTER**.

3 Press **▲ / ▼** to select "ON".

- Each time the button is pressed, the mode changes in the following sequence:

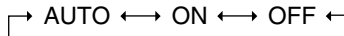

4 While the "**G** ON" is displayed, press **◀ / ▶** to select the level.

- The level selection indicator that shows the current level appears.



- Press **RETURN** to return to the previous screen.

5 Press **SET/ENTER** to confirm the setting.

- You can go on to specify other settings.

6 Press **SETUP/FUNCTION** or **RETURN** to return to the normal playback screen.

Direct Selection of Scenes



Selecting Scenes by Title Number

DVD VIDEO | DVD RW VIDEO MODE | DVD R

NOTE

- This function only work on the finalized DVD-R or DVD-RW (Video mode).

1 Press **TITLE** to show the title screen.

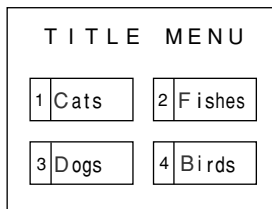

2 Press **◀/▶** to select the desired title.

3 When you press **SET/ENTER**, the title specified in step 2 starts playing.

NOTE

- The above procedure indicates the standard operating procedure. Since the procedure may be different depending on the DVD video disc, follow the procedure indicated in the user's manual provided with the DVD video disc or displayed on the screen.

About the Title Menu

- There are some DVD video discs that use the word "Top Menu" when explaining the title menu. In these explanations, the button referred to as the "Top Menu" is equivalent to the **TITLE** on this recorder.
- The Title screen will not be displayed when pressing **TITLE** if no titles are recorded on the disc.

Disc Menu Screen

DVD VIDEO

Example: Selecting "LANGUAGE"

1 Press **MENU** to display disc menu screen.



2 Press **▲/▼** to select "LANGUAGE".

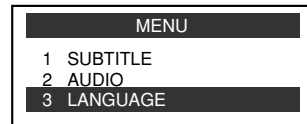

3 Press **SET/ENTER** to display language screen.

4 Press **▲/▼** to select language.

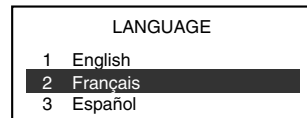

5 Press **SET/ENTER** to confirm the setting.

NOTE

- The above procedure indicates the standard operating procedure. Since the procedure may be different depending on the DVD video disc, follow the procedure indicated in the user's manual provided with the DVD video disc or displayed on the screen.

Recording for DVD Discs



Before Recording

Recordable Discs

DVD-RW Discs

- DVD-RW discs make it possible to repeatedly make about 1,000 recordings of high-quality sound and pictures attainable.
- There are two types of DVD-RW discs consisting of Ver. 1.1 and Ver. 1.1 (CPRM). These discs can be recorded while selecting the preferred mode from two different recording formats (VR mode or Video mode).

DVD-R Discs

- DVD-R discs are able to record the high quality pictures only once.
- DVD-R discs can only be recorded in the Video mode.

NOTE

- When using DVD-RW discs in the Video mode, record these discs after first initializing the disc in the Video mode. For further details, read the section on "VIDEO MODE INITIALIZE" (page 88) of Disc Setup.
- When recording onto DVD-RW or DVD-R discs, it takes a while until recording begins (about 2 seconds for DVD-RW discs and about 10 seconds for DVD-R discs). Make sure to press **REC** earlier when recording onto DVD-RW or DVD-R discs.

About the Recording Format

VR mode: When you want to edit recorded material

Video mode: When you want to enjoy recorded material with another DVD player (playback with all DVD players is not guaranteed)

- DVD-RW discs that have been recorded in the VR mode can be played back with DVD recorders indicated as being "RW COMPATIBLE".



NOTE

- Recorded materials must be finalized (page 88) in order to be viewed with another DVD player.
- Materials recorded in the VR mode and the Video mode cannot be contained on the same disc.

Before Starting Recording

- Refer to "About Recording" on page 9 for information on recording.

NOTE

DVD recorders perform high-precision recording. Pay attention to the following matters so that data is recorded accurately on the disc.

- Do not subject the recorder to impacts.
- Do not use the recorder in unstable locations or locations subject to vibrations.
- Do not unplug the recorder during recording, writing of data, editing, initialization, finalizing or any other occasions when the recorder is operating. Unplug the recorder only after turning the power "OFF". Furthermore, the manufacturer is not responsible for compensation for the contents of data in the case data has been lost or was not recorded.
- Titles for which recording has been interrupted due to a scratched disc, soiled disc or other reason are displayed with an exclamation point "!" in front of the title displayed on the DiscNavi menu and so forth.

* CD-R and CD-RW discs cannot be recorded with this recorder.

Initialization

DVD-RW discs must be initialized (formatted) before using for recording. (Since DVD-R discs are not required to be initialized, they can immediately be recorded in the Video mode.)

Initializing in the VR Mode

When an unused disc is loaded onto the recorder, it is automatically initialized in the VR mode.

Recording for DVD Discs



Initializing in the Video Mode

When a disc that has been initialized in the VR mode is used in the Video mode, select initializing in the Video mode in Disc Setup of the Initial Setup menu.

- The setting can be changed so that unused discs are automatically initialized in the Video mode when loaded onto the recorder (page 86).

Recording Formats and Recording Modes

The recording modes that can be set differ depending on the recording format (VR mode or Video mode).

Recording format	Recording mode			
	FINE	SP	LP	EP
VR mode	About 60 min. (About 90 min.)	About 120 min. (About 180 min.)	About 240 min. (About 300 min.)	About 360 min.
Video mode	About 60 min. (About 90 min.)	About 120 min. (About 180 min.)	About 240 min.	—

- Recording time is based on the recording time when using a 4.7 GB disc.
- Values for recording time shown in parentheses () provide a general indication of recording time when timer recording has been made with "EXACT REC" set to "ON".

Disc Information

```

TYPE      :DVD-VIDEO
TITLE     :05
CHAPTER  :019

REMAIN: 1h57m SP
DISC     :OFF PROTECT:OFF
NOT FINALIZE
    
```

Disc information provides you with the remaining time on the disc, titles that have been recorded and other information. It is recommended to check disc information before recording.

- Disc information can be displayed while the disc is stopped by pressing **ON SCREEN** (page 28).
- Up to 99 original titles and Playlist titles each can be created on VR mode discs. Up to 99 titles can be created on Video mode discs.

- Although the number of chapters that can be created on a single disc varies according to available memory space, it is generally around 200 chapters. However, only up to 50 unerasable chapter marks (chapter marks that are automatically created when a part has been added or erased) can be created on a single disc.
- When an unrecordable disc has been loaded onto the recorder, the remaining recording time is displayed as "0h00m" and blinking. In addition, the remaining recording time is displayed as "0:00" and blinking when the on-screen display is set to "ON".

Confirmation of Available Disc Space

- Confirm remaining recording time by setting the on-screen display to "ON".
- When the remaining recording time is "0:00" (when blinking), no further material can be recorded on that disc. Replace the disc with a different recording disc.

```

T 03 VR   ORG
- - - - - DVD-RW
REM 1:59SP 02
    
```

- Remaining recording time can also be confirmed by pressing **DISPLAY** on the remote control during recording. The display changes in the order shown below each time it is pressed.

→ T--C--- → Counter → Remain Time
Channel ← Operation Status ←

- The disc remaining recording time display serves as a general indicator of the amount of available space on the disc. Available space may still be remaining on the disc when recording is completed. (The display of remaining recording time during recording and that of when recording is completed may not always be identical.)

TV Program Recording



When recording TV programs, an once recording (from the start of recording until recording stops) is recorded as a single "title".

Basic Recording

DVD RW | DVD RW | DVD R
VR MODE | VIDEO MODE

- 1 Turn on the TV and switch the TV channel to the external "VIDEO" or "AV" channel connected to the VIDEO/AUDIO output jacks.**
- 2 Press POWER.** The recorder is turned on.
- 3 Press OPEN/CLOSE to open the disc tray.**
- 4 Load the disc onto the tray.**
 - Hold the disc without touching either of its surfaces, position it with the printed title side facing up.

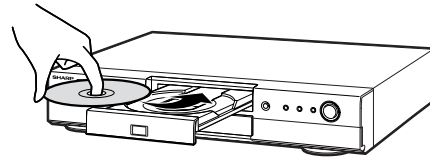

- 5 Press OPEN/CLOSE to close the disc tray.**
 - When the disc is being identified ("LOAD" is displayed on the Front Panel Display), the DISC IN indicator on the Front Panel is blinking. The indicator lights when the disc is finished being identified ("LOAD" disappears).
 - If you load a completely blank disc, the recorder takes a short while to initialize the disc. (It takes around 60 to 90 seconds.)
- 6 Press CH ▲ / ▼ to select the TV channel to record.**
 - Check whether the channel is set to the channel you want to record on the TV screen.
- 7 Press REC MODE to select the recording mode.**
 - Current mode is displayed on the TV screen and Front Panel Display.

- Each time **REC MODE** is pressed, the mode changes as follows:

VR mode:

→ FINE → SP → LP → EP →

Video mode:

→ FINE → SP → LP →

8 Press ●REC.

DVD-RW:

Recording starts immediately.

- The recording indicator on the Front Panel Display lights up.

DVD-R:

The recorder prepares to start recording when setting "R REC START" in "RECORD SETUP" to "2 PRESS". Press ●REC again to start recording.

- Recording continues until you press ■STOP or the disc is full.
- If you prefer DVD-R recording to work in the same way as recording to DVD-RW, set "R REC START" in "RECORD SETUP" to "1 PRESS".

! Important!

- When you record SAP broadcast, setting "SAP" in "RECORD SETUP" to "ON" (See page 87).

TV Program Recording



NOTE

- Recorded images may not appear correctly on the screen when viewing broadcasts with poor reception. This may be improved by resetting "3D Y/C" to "OFF" (page 91).
- Discs edited with another recorder that contain more than 201 chapter marks cannot be edited (or recorded) with this recorder.
- Discs on which parts have been added or erased more than 51 times for a single title with another DVD recorder, and discs that are protected cannot be edited (or recorded).
- Titles for which recording has been interrupted due to a scratched disc, soiled disc or other reason are displayed with an exclamation point "!" in front of the title displayed on the DiscNavi menu and so forth.

When Recording Discs are Scratched or Soiled

- Recording may be temporarily interrupted at those portions of a disc that cannot be recorded as a result of being scratched or soiled. When recording is resumed, the portion where recording starts is recorded as a different title. When a disc is unable to be recorded, "INCORRECT TYPE. REMOVE DISC." will appear and all other functions of the recorder will be disabled except for opening and closing of the tray. Take out the disc when this happens.
- When recording in the Video mode, a maximum of about 60 seconds of recorded material prior to the point where recording is interrupted may be lost.

Pause Recording

DVD RW | DVD RW | DVD R
VR MODE | VIDEO MODE

1 Press **|||STILL/PAUSE** during recording.

- This function does not work during timer recording and Simple Recording Timer.
- Although the channel can be changed while recording is paused, the recorded title does not change. (The name of the title is the same as that of the previous channel.)

2 Press **|||STILL/PAUSE** or **●REC** to start recording again.

NOTE

- In the case of a VR mode disc, a chapter mark is automatically inserted at the location where recording is paused.
- When recording onto a DVD-RW disc, the channel cannot be changed if recording is paused by pressing **|||STILL/PAUSE** immediately after having pressed **●REC**.

TV Program Recording



Stop Recording

DVD RW | DVD RW | DVD R
VR MODE | VIDEO MODE

Press **■STOP** during recording.

- Stop recording before you remove the disc from the recorder,

NOTE

- Since images are recorded in 30 second units in the Video mode (1 minute units in the LP mode), images may be briefly recorded after recording has been stopped. In this case, if recording is stopped after first pausing the recording, a black screen will be recorded for up to 30 seconds (or up to 1 minute in the LP mode).
- A black screen may be recorded at the end of a recording when a recording in the VR mode is stopped after pausing.
- Erase recorded titles when they are no longer required (page 71). In the case of a disc recorded in the VR mode, remaining recording time increases by the amount of original titles erased. In the case of discs recorded in the Video mode, although titles are no longer displayed, remaining recording time does not increase. (In the case of DVD-RW discs, remaining recording time only increases when the last title has been erased.)
- **■STOP** does not function for the first 5 seconds of a recording. (Press **■STOP** 5 or more seconds after recording begins.)

Useful Recording Functions

■ Watching Other TV Programs while Recording

- The TV channel can be changed by pressing the channel button on the TV. The TV can also be turned off.

■ Accurately Starting Recording from a Desired Part

When recording onto a DVD-RW or DVD-R disc, a brief amount of time is required until recording begins (about 2 seconds for DVD-RW discs and about 10 seconds for DVD-R discs). Start recording using the following procedure when you want to start recording at a precise time.

● When recording onto a DVD-RW disc:

- Press **■STILL/PAUSE** immediately after earlier pressing **●REC** to pause recording, and then once the recording reaches the scene you want to record, press **●REC** to start recording from that scene.
- **■STOP** does not function while recording is paused. If you want to stop recording, press **■STOP** after waiting at least 5 seconds after recording has started.

● When recording onto a DVD-R disc:

- Set the "R REC START" setting of the "RECORD SETUP" to "2 PRESS". Recording is paused for about 10 seconds later after **●REC** is pressed once. When **●REC** is pressed for a second time while recording is paused, you can accurately start recording from the scene you want to record.
- If "R REC START" of the "RECORD SETUP" is set to "1 PRESS", recording starts automatically about 10 seconds later after **●REC** is pressed (the Pause function does not function).

Simple Recording Timer



DVD RW | DVD RW | DVD R
VR MODE VIDEO MODE

The Simple Recording Timer (SRT) enables you to set the recording stop time. The SRT can be set on the TV screen by using the remote control.

! Important!

The SRT cannot be set if the clock has not been set. Make sure the clock is set before setting the SRT.

1 Perform the steps 1 to 8 of “Basic Recording” on page 48.

2 Press **●REC** during recording.

- Each press of **●REC** increases the stop time by 10 minutes.

Example: Stop the recording at 9:40 AM.



- When the stop time comes, recording is finished, and the power turns off.

Changing the Settings of the Simple Recording Timer

1 Press **●REC**. The stop time is blinking on the TV screen.

2 Press **●REC** to change the stop time as desired.

Cancelling the Simple Recording Timer

Press **■STOP**.

NOTE

- The Simple Recording Timer has priority over other recordings.
- Ordinary timer programs will not be recorded when portions of the time setting of the simple recording timer and of the time setting of the ordinary timer recording overlap.

Example:

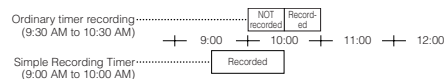

Timer Recording with VCR Plus+® System

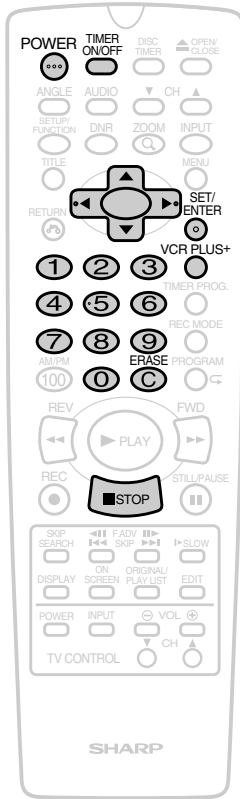

DVD RW | DVD RW | DVD R
VR MODE | VIDEO MODE

The VCR Plus+ Programming System allows you to program your recorder for timer recording simply by inputting the PlusCode Programming number.

The PlusCode numbers are listed in most newspaper, television guides, and local CATV listings. Simply by inputting this PlusCode number, you can program your recorder for timer recording, eliminating the need to input program start time, stop time, channel, date and other information necessary for timer recording.

Up to 8 timer programs can be stored in the recorder.

1 Press POWER and load a recordable disc.

- Timer recording does not work during loading a disc. Start the timer setting after the disc is finished being identified.

! Important!

- Check that the clock is displaying the correct time.
- When you record SAP broadcast, setting "SAP" in "RECORD SETUP" to "ON" (See page 87).
- When you press **STOP** to stop timer recording, the timer standby mode will be canceled. Press **TIMER ON/OFF** to enter the timer standby mode if you set other timer recordings. The **TIMER** indicator lights up.

2 Press VCR PLUS+ to display the VCR PLUS+ setting screen.

- If you press **VCR PLUS+** when the clock has not been set, the clock setting screen will appear.

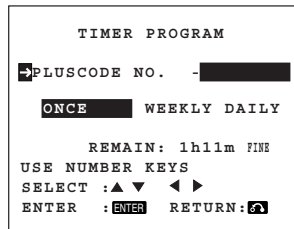

3 Press number buttons to enter "PLUSCODE NO." and then press ▼.

- If you make a mistake in entering the numbers, press **ERASE** to erase the numbers one by one or press **◀/▶** to move the cursor, then re-enter the correct number.

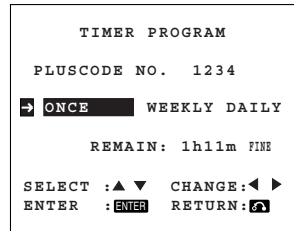

4 Press ◀/▶ to select "ONCE", "WEEKLY" or "DAILY" and then press SET/ENTER.

- **ONCE**: To record only once.
- **WEEKLY**: To record every week at the same time.
- **DAILY**: To record everyday at the same time.

5 The timer program information is shown on the TV screen. Check the contents.

- If you want to change any settings, press **◀/▶** to select items and press **▲/▼** to correct.
- When recording a program on a channel for the first time, you must enter the correct channel number on the screen, otherwise the PlusCode number will not be successfully decoded.

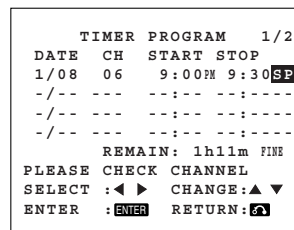

6 Press SET/ENTER. The VCR PLUS+ setting screen will appear. To program additional timer settings, repeat steps 3 to 6.

Timer Recording with VCR Plus+® System

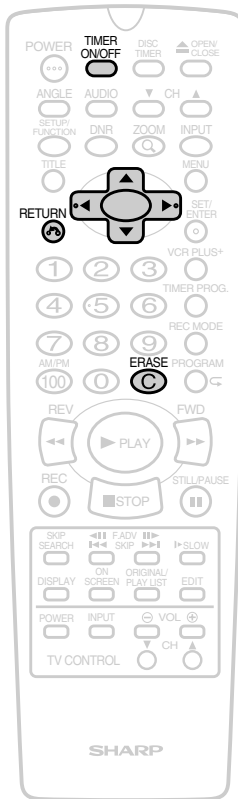

7 Press **RETURN** to return to the normal screen.



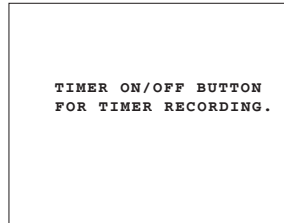

- The display appears shown below.



8 Press **TIMER ON/OFF** to enter the timer standby mode.

- **TIMER** indicator on the front of the recorder will light up.
- Timer recording will not work if the recorder is left on.

NOTE

- If you select "DAILY" in step 4, the recorder will record the program Monday-Sunday at the same time.
If you want to record Monday-Friday or Monday-Saturday, select "DATE" with  /  and change it to "MO-FR" or "MO-SA" with  /  in step 5.
- In step 5, input the channel number you want to record. Once the preset channel has been input, you will not need to set the preset channel for that station again.
- In step 4, if the recorder cannot decode the PlusCode number, or if the combination of PlusCode number and Program mode does not exist, then "ERROR" will appear. To correct, press **ERASE** and re-enter the PlusCode number.
- The following causes are possible when the **TIMER** indicator is blinking or "ERROR" is displayed when **TIMER ON/OFF** has been pressed.
 - A recording has been programmed having a recording time of 1 minute
 - Inadequate available disc space
 - The disc is protected
 - No disc is loaded in the recorder
 - Disc identification is not finished
Repeat the procedure after checking the recording time and disc.

Checking/Cancelling the VCR Plus+ Programming System

Use the procedure described in "Confirming/Cancelling Timer Program" to confirm or cancel program data (See page 59).

Timer Recording



DVD RW VR MODE DVD RW VIDEO MODE DVD R

Important!

- Check that the clock is displaying the correct time.
- When you record SAP broadcast, setting "SAP" in "RECORD SETUP" to "ON" (See page 87).
- When you press **STOP** to stop timer recording, the timer standby mode will be canceled. Press **TIMER ON/OFF** to enter the timer standby mode if you set other timer recordings. The **TIMER** indicator lights up.

NOTE

- Up to 8 timer programs can be stored in the recorder.
- "DV" cannot be set for the channel reserved for timer recording.
- When "0h00m" is blinking as the remaining recording time in the disc information after disc identification, the disc loaded cannot be used for recording. Replace it with a different disc.
- Set the duration of recording time to at least 2 minutes. Recordings of 1 minute cannot be programmed.

Example: Recording a TV program in the FINE mode: the TV program is on channel 7 starting at 9:05 PM and stopping at 10:35 PM on August 10th.

1 Turn on the recorder and load a recordable disc.

- Timer recording does not work during loading a disc. Start the timer setting after the disc is finished being identified.

2 Press **TIMER PROG.** to display the **TIMER PROGRAM** screen.

- If you press **TIMER PROG.** when the clock has not been set, the clock setting screen will appear.

```

TIMER PROGRAM 1/2
DATE CH START STOP
-/- - - - - - - - -
-/- - - - - - - - -
-/- - - - - - - - -
-/- - - - - - - - -
▼ 2/2 REMAIN: 1h11m FINE
CLEAR : C
SELECT : ▲ ▼
ENTER : ENTER RETURN: RETURN
    
```

3 Press **SET/ENTER** to set the timer program.

4 Press **▲ / ▼** to select the desired month/day (DATE) and then press **▶**. The cursor will move to the next column.

Example: August 10th

- If you want to record every day or week at the same time, hold when you select the date.

When pressing: The recording date changes in this sequence:

▼ 8/10-MO-FR→MO-SA→DAILY→SAT-SUN-8/9-8/8-- (next year)
 ▲ 8/10 → 8/11 → 8/12 → 8/8 → 8/9 → SUN → SAT → (present) (tomorrow) (next year)

```

TIMER PROGRAM 1/2
DATE CH START STOP
8/10 - - - - - FINE
-/- - - - - -
-/- - - - - -
-/- - - - - -
REMAIN: 1h11m FINE
SELECT : ◀ ▶ CHANGE: ▲ ▼
ENTER : ENTER RETURN: RETURN
    
```

5 Press **▲ / ▼** to select the desired channel and then press **▶**.

6 Press **▲ / ▼** to set the recording start time (hour digits and minute digits) and then press **▶**.

Press **AM/PM** to select "AM" or "PM".

7 Press **▲ / ▼** to set the recording stop time and then press **▶**.

It is not necessary to select AM or PM.

8 Press **▲ / ▼** to select the recording mode.

Example: SP

```

TIMER PROGRAM 1/2
DATE CH START STOP
8/10 07 9:05PM10:35SP
-/- - - - - -
-/- - - - - -
-/- - - - - -
REMAIN: 1h11m FINE
SELECT : ◀ ▶ CHANGE: ▲ ▼
ENTER : ENTER RETURN: RETURN
    
```

Timer Recording



9 Press **SET/ENTER**.

- To program additional timer settings, press **SET/ENTER** and repeat steps 3-9.

10 Press **RETURN** to finish settings.

11 Press **TIMER ON/OFF** to enter the timer standby mode.

- The power turns off, and the recorder enters the timer standby mode (the **TIMER** indicator on the recorder lights up).
- During playback, the power does not turn off, but the timer recording will be set.

NOTE

- If the power is interrupted for more than 1 hour (power failure, etc.) during timer recording, the Auto Clock Setting will reset the time after the power is returned (the timer indicator on the Front Panel Display will blink.) but the timer settings will be canceled.
- Number buttons can be used instead of **▲** / **▼** to set the data.
- To stop timer recording, press **■STOP**.
- If a button is not pressed within 3 minutes during the setting procedure, the screen will return to the normal screen.
- There are two timer setting screens (1/2, 2/2).
- The following causes are possible when the **TIMER** indicator is blinking or "ERROR" is displayed when **TIMER ON/OFF** has been pressed.
 - A recording has been programmed having a recording time of 1 minute
 - Inadequate available disc space
 - The disc is protected
 - No disc is loaded in the recorder
 - Disc identification is not finishedRepeat the procedure after checking the recording time and disc.

Disc Timer Recording



DVD RW | VR MODE

- Disc timer recording is a function that lets you record programming information directly onto a disc. Since programming information is recorded onto the disc itself, recording is programmed simply by placing the disc in the recorder. It is useful when recording a particular program either every week or every day.
- A single disc can be programmed with up to 8 timer recordings, including daily and weekly programming.
- When programming recording information directly on a disc, use a DVD-RW disc that has been initialized in the VR mode.

1 Press **POWER** and then load a **DVD-RW disc**.

- Timer recording does not work during loading a disc. Start the timer setting after the disc is finished being identified.

2 Press and hold **DISC TIMER** for more than 2 seconds.

- The DISC TIMER indicator on the recorder lights up and the recorder enters the Disc Timer Recording mode.
- If a disc that has already been programmed disc timer recording is loaded, the recorder enters the Disc Timer Recording mode automatically.

3 Set the timer recording. (See “Timer Recording” on page 54 or “Timer Recording with VCR Plus+® System” on page 52.)

- If a disc that has already been programmed disc timer recording is loaded, go to step 4.

4 Press **TIMER ON/OFF**.

- The recorder is turned off and the TIMER indicator on the recorder lights up (Timer standby mode).
- Make sure to check both the TIMER indicator and the DISC TIMER indicator light up.



TIMER DISC
TIMER

NOTE

- DVD-R discs and DVD-RW discs initialized in the Video mode cannot be used for disc timer recording.
- Disc timer recording and standard timer recording cannot be performed simultaneously.
- If disc timer recording is set for a disc that has not been programmed for disc timer recording, the recorder will not enter the disc timer recording mode until the disc has finished being identified.
- In the case of loading a disc in this recorder for which the disc timer recording has been programmed with another recorder, check the contents of the recording have been programmed since this recorder has four types of recording modes.
- When “0h00m” is blinking as the remaining recording time in the disc information after disc identification, the disc loaded cannot be used for recording. Replace it with a different disc.



Disc Timer Recording



Canceling the Disc Timer Recording

Follow the procedure shown below when you want to cancel disc timer recording and use standard timer recording. (Disc timer recording is not canceled even after the recording program has ended.)

■ **When a disc containing a disc timer recording program is set in the recorder and is ready for recording (the DISC TIMER indicator and TIMER indicator are lit)**

- 1 Press TIMER ON/OFF.**
The TIMER indicator turns off.
- 2 Turn on the power.**
- 3 Cancel the disc timer recording.**
Refer to page 59 for how to cancel the disc timer recording.
- 4 Press and hold DISC TIMER for at least 2 seconds.**

- When you want to use standard timer recording with a disc containing a disc timer recording program, cancel disc timer recording by performing steps **3** and **4**.
- Disc timer recording can also be canceled by removing the disc containing the disc timer recording program.

■ **When a disc containing a disc timer recording program is set in the recorder and the recorder is in the disc timer recording mode (only the DISC TIMER indicator is lit)**

Press and hold DISC TIMER for at least 2 seconds.

NOTE

- The following causes are possible when the TIMER indicator is blinking or "ERROR" is displayed when **TIMER ON/OFF** has been pressed.
 - A recording has been programmed having a recording time of 1 minute
 - Inadequate available disc space
 - The disc is protected
 - No disc is loaded in the recorder
 - Disc identification is not finished
 Repeat the procedure after checking the recording time and disc.
- Disc timer recording and standard timer recording cannot be performed simultaneously.
- Disc timer recording is canceled when the disc is removed.

Important!

- Recordings cannot be programmed when the power is turned off or when a VR mode DVD-RW disc is not set in the recorder.

Using the Recorder During Timer Standby Mode

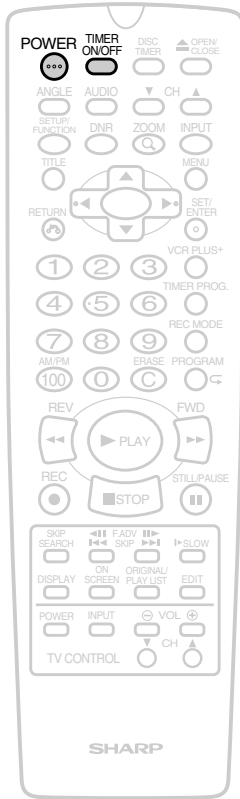

This recorder cannot be used during timer standby. When you want to play back a disc that is different from the disc to be used for timer recording, first cancel timer standby.

DVD RW | DVD RW | DVD R
VR MODE VIDEO MODE

- 1 Press TIMER ON/OFF.**
 - The TIMER indicator turns off and timer standby is canceled.
- 2 Press POWER.**
 - The recorder can now be operated.

When Finished Using the Recorder

- 1 Load a disc to be used for timer recording.**
 - Once disc identification (loading) is completed, press **TIMER ON/OFF**. The recorder will not enter recording standby unless disc identification has been completed.
- 2 Press TIMER ON/OFF.**
 - The power is turned off and the TIMER indicator lights up to indicate timer standby.



TIMER

Confirming/Cancelling Timer Program

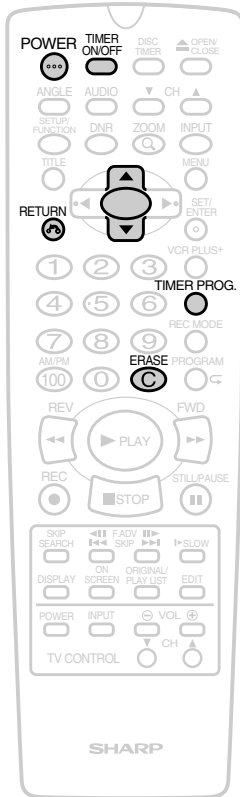

DVD RW | DVD RW | DVD R
VR MODE VIDEO MODE

You can see on the timer setting screen a list of timer programs that are already set.

1 When the mode is timer standby mode, press **TIMER ON/OFF** to cancel the timer standby mode and then press **POWER**.

2 Press **TIMER PROG.** to display the **TIMER PROGRAM** screen.

- All timer programs that are already set are displayed on the **TIMER PROGRAM** screen.

3 If you want to cancel the data, select the data to be canceled with **▲/▼** and then press **ERASE**.

See 2/2 screen also.

TIMER PROGRAM 1/2			
DATE	CH	START	STOP
8/01	125	12:00PM	12:30EP
8/10	07	9:05PM	10:35SP
-/-	-	-:-	-:-
-/-	-	-:-	-:-
▼ 2/2 REMAIN: 1h11m FINE			
CLEAR	: C		
SELECT	: ▲ ▼		
ENTER	: ENTER RETURN: C		

4 Press **RETURN** to return to the normal screen.

- During playback or recording (Timer recording), you cannot confirm or cancel the programs.
- After checking or cancelling the program contents, press **TIMER ON/OFF** to enter the Timer Standby mode if you have other timer recordings.

TIMER ON/OFF BUTTON
FOR TIMER RECORDING.

Automatic Recording of Satellite Broadcast (AV AUTO REC)



DVD RW | DVD RW | DVD R
VR MODE | VIDEO MODE

When connected to a Satellite receiver, etc. with timer recording functions, this recorder can be used to automatically record the timer program. (Refer to the operation manual of the Satellite receiver, etc. for instructions on how to set the timer program.)

Example: Use of AV AUTO REC Function

Satellite receiver, etc.	2:00 AM	3:00 AM	4:00 AM	5:00 AM
Set timer program	Program Timer		Program Timer	
DVD Recorder	2:00 AM	3:00 AM	4:00 AM	5:00 AM
Set AV AUTO REC function	Records timer program		Records timer program	
	Recording begins	Recording ends	Recording begins	Recording ends
	Power ON	Power OFF	Power ON	Power OFF

NOTE

- The AV AUTO REC function only operates when used with a Satellite receiver, etc. with timer recording functions.
- The AV AUTO REC function will not operate when the Satellite receiver, etc. is connected to the IN 3 jacks on the rear of the recorder or the IN 2 jacks on the front of the recorder.

Recording with AV AUTO REC

- Set up the Satellite receiver, etc..**
 - Set the recording timer on the Satellite receiver, etc. for the program you wish to record. (Refer to the operation manual of the Satellite receiver, etc. for instructions on how to set the timer program.)
- Turn off the Satellite receiver, etc..**
- Load a recordable disc into the recorder.**
- Press POWER to turn off the recorder.**
- Press and hold REC MODE for more than two seconds. The AV AUTO REC indicator on the recorder will lights up.**
 - The recorder will automatically turn on and begin recording and then stop recording and turn off, according to the timer program setting on the Satellite receiver, etc..

Connecting to a Satellite receiver, etc.

To use the AV AUTO REC function, connect the Satellite receiver, etc. to the **VIDEO/AUDIO IN 1 jacks** on the rear of the recorder.

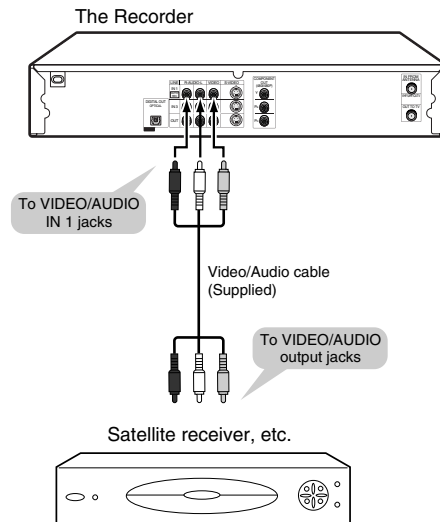

Automatic Recording of Satellite Broadcast (AV AUTO REC)



To Cancel the AV AUTO REC Function

Before Recording

Press **POWER**.

- The recorder is turned on and the AV AUTO REC indicator will be turned off.



AV AUTO REC

During Recording

Press and hold **REC MODE** for more than 2 seconds.

- The AV AUTO REC indicator will be turned off and become normal recording mode. Press **STOP** to stop recording.

- Timer recording is given priority when timer recording and AV AUTO REC times overlap.

NOTE

- When recording PPV (pay-per-view) programs of satellite broadcasts, always make sure to set the satellite receiver, etc. to "Record". Certain programs may not be able to be recorded or require additional charges.
- Only DVD-RW Ver. 1.1 (CPRM-compatible) discs in the VR mode can be used to record "Copy-once" satellite broadcasts, etc.
- Use AV AUTO REC in combination with a satellite broadcast receiver, etc. equipped with a programming function.
- Since the power of this recorder is switched on after the video signal from a satellite receiver, etc. has been received, the start of a program may not be recorded.
- When a timer recording is started during AV AUTO REC, since disc information is written at the point recording switches to timer recording, the start of timer recording is delayed by a maximum of about 1 minute.
- AV AUTO REC cannot be set while the simple recording timer is being set.
- In the case AV AUTO REC starts after the start of timer recording, the recording mode will be the one set with timer recording.

Problems of Timer Recording

Blinking the TIMER Indicator

Timer recording cannot be performed in the situations shown below. Check the contents of the error and reprogram timer recording correctly. When an error occurs, the TIMER indicator on the recorder blinks for about 5 seconds.

	Front Panel Display	Causes	Solution	Setting correctly
TIMER indicator is blinking.	NO DISC	• There is no disc loaded	<ul style="list-style-type: none"> • Load a disc for recording, and after the disc has finished being identified, press TIMER ON/OFF to enter standby. • When a disc for recording has already been loaded in the recorder, turn on the power and after the disc has finished being identified, press TIMER ON/OFF to enter standby. • Enter standby after either canceling the disc protect function or loading a different disc for recording in the recorder. 	
	_____	• A non recordable disc is loaded		
	DISC FULL	• There is enough blank space on the disc		
	_____	• The disc is unplayable		
Timer recording does not work.	_____	• The disc that's loaded is protected	• Repeat timer recording after deleting some of the timer program.	TIMER indicator lights up.
	TIMER FULL	• Timer Recording is full	• Repeat timer recording after setting the clock.	
	ERROR	<ul style="list-style-type: none"> • The clock has not been set. • The channel is incorrect • The Recording time is set at 1 minute 	<ul style="list-style-type: none"> • Check the channel that has been programmed for timer recording. • Reset the recording time to 2 minutes or more. 	
		<ul style="list-style-type: none"> • The clock on the recorder is not set • Timer Recording or Simple Recording Timer has been set • Timer Recording is full 	<ul style="list-style-type: none"> • Repeat timer recording after setting the clock. • Program timer recording after the timer recording menu or simple recording menu has finished. • Repeat timer recording after deleting the timer program. 	

NOTE

- Press **STOP** when you want to discontinue recording while timer recording is in progress. Timer recording is canceled when **STOP** is pressed. When there are other timer programs, enter standby by pressing **TIMER ON/OFF**.
- When timer programs are programmed that have the same recording starting date and time, the first timer program is overwritten.

When Timer Recording Times Overlap

Problem	Helpful Hint
Timer recording times overlap	<p>■ If two timer recording times overlap, the second timer program starts after the first timer program is finished.</p> <p>Example: <Recording Times set></p> <p><Recording actually made></p>

NOTE

- When multiple timer programs have been set and the timer recording times overlap or the ending time of the first timer program overlaps the starting time of the second timer program, disc information is written and the second timer program starts after the first timer program is finished. Consequently, the start of the second timer program is delayed by a maximum of about 1 minute.

Editing the Disc

Before Editing the Disc

About Editing

Recorded contents that can be edited and the editing procedure differ depending on the mode in which the contents were recorded.

● When Recorded in VR Mode

Editing can be performed with this recorder alone such as gathering your favorite parts from recorded titles to create your own collection of personal favorites, relocating parts within a specified range, or erasing unnecessary parts. You can also create a "Playlist" from original recordings, or edit original recordings directly. (Those materials that can be edited differ between original recordings and playlists.)

Original

Recordings generated in the same manner in which they were recorded are referred to as originals. An once recording (from starting to stopping of the recording) is treated as a single title.

Playlist

Titles created based on an original are referred to as a Playlist. Playlists can be recreated as many times as you desire.

* A Playlist consists of a list that describes the order in which originals are to be played back, and is not an actually copy of the original. This lets you edit using less disc space.

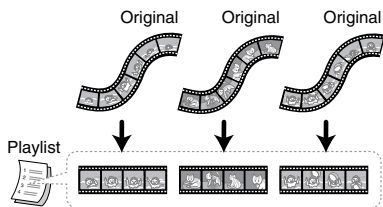

● When Recorded in Video Mode

Playlists cannot be created from recordings recorded in the Video mode. Recorded contents that can be edited are indicated below.

- Input the title names (page 66)
- Erasure of titles (page 71)
 - * "Title erasure" in the case of recordings that have been recorded in the Video mode is provided so that the title is no longer displayed during playback, and does not mean that the recording is actually erased. (Remaining recording time does not increase. However, in the case of DVD-RW discs that have been recorded in the Video mode, remaining recording time can be increased only by erasing the last recorded title.)
 - * Discs cannot be edited after they have been finalized (page 88).
 - * Recordings can be added and edited with this recorder only until a disc has been finalized.

Editing Procedure

This is the basic procedure when editing titles of originals that have been recorded in the VR mode.

Load a disc.

Select the desired title and then edit the title.

- Erasing a part from Original (See page 65).
- Inputting/Renaming the Title (See page 66).
- Adding Chapter Markers (See page 66).
- Navimark (See page 68).
- Protecting the Title (See page 69).
- Erasing the Titles (See page 71).

This is the basic procedure when editing titles that have been recorded in the VR mode after creating a playlist.

Load a disc.

Making a New Playlist

- Making a Playlist from Original Title (See page 72).
- Adding a part to the Playlist (See page 73).

Select the Playlist and then edit.

- Erasing the Titles (See page 71).
- Erasing a Part from the Playlist (See page 75).
- Moving the Title (See page 75).
- Adding a Part from the Original to the Playlist (See page 76).
- Adding Chapter Marker in a Playlist (See page 77).
- Renaming the Title (See page 78).
- Navimark (See page 79).



Editing the Disc



Switching between Playlist and Original Playback

Switching Between Original and Playlist when Power is turned ON



Example of Original screen
The screen for editing originals is displayed when operation is switched to DiscNavi or editing.

ORIGINAL/PLAY LIST



Press this button to switch between Original and Playlist



Example of Playlist screen
The screen for editing the playlist is displayed when operation is switched to DiscNavi or editing.

NOTE

- The display does not switch to the Playlist screen when a playlist has not been created.
- Operation automatically returns to Original if contents are recorded when editing is switched to Playlist.

Switching Between Original and Playlist with DiscNavi

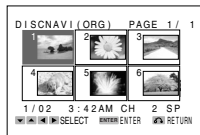

Example of Original screen
Switches when an Original is played back.

ORIGINAL/PLAY LIST



Press this button to switch between Original and Playlist

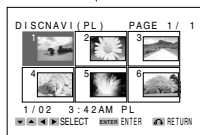

Example of Playlist screen
Switches when a Playlist is played back.

NOTE

- The display does not switch to the Playlist screen when a playlist has not been created.

Switching to Original Editing Screen during Playback



EDIT



The display switches to the editing screen when EDIT is pressed during playback.

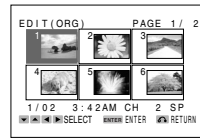

NOTE

- Discs that have been edited with another DVD recorder and contain more than 201 chapter markers cannot be edited (recorded) with this recorder.
- Discs on which parts have been added or erased more than 51 times for a single title with another DVD recorder, and discs that are protected cannot be edited (or recorded).

This recorder cannot be used to edit exact frames.

- When editing a recording by adding chapter markers or erasing parts and so forth, there may be a slight discrepancy between the frames to be edited and the frames that are actually edited.
- When playing back a disc that has been edited in frame units with another DVD recorder, the start and end points may be altered slightly, or the DiscNavi screen may be slightly different.



Editing an Original Title



Erasing a Part from the Original

DVD RW
VR MODE

You can erase a part of a title currently in the Original content.

- You cannot edit a finalized disc recorded in Video mode.

1 Press **EDIT** while the disc is stopped.

- The Original Edit Title List screen appears.

2 Press **▲/▼/◀/▶** to select the title and then press **SET/ENTER**.

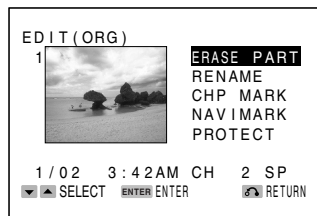

3 Press **▲/▼** to select "ERASE PART." and then press **SET/ENTER**.

- The selected title is played back.

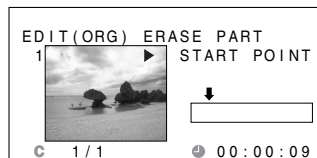

- Press **▶PLAY, FWD▶▶, ◀◀REV, STILL/PAUSE, I◀◀SKIP, SKIP▶▶** or **▶SLOW** to find the part to erase.

4 Press **SET/ENTER** to set the start point of the part to erase.

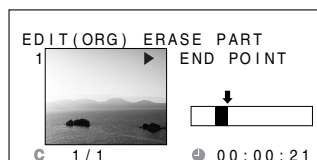

5 Press **SET/ENTER** to set the end point of the part.

- The title will become still mode.

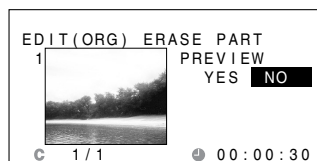

6 When you confirm the part to erase, press **◀** to select "YES" and then press **SET/ENTER**.

- The title is played back without the erased part.

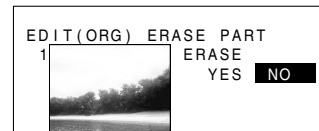

7 Press **◀** to select "YES" and then press **SET/ENTER**.

- The selected part is erased.

8 Press **EDIT** to exit the edit mode.

Resetting Start and End Points

- The start point and end point can be reset until a part is erased. After returning to setting of start point and end point with **RETURN**, reselect the part using the procedures of steps 4 and 5.
- The start point is canceled when **◀◀REV** and **I◀◀SKIP** are pressed to go back to before the start point after the start point has been set.
- Some playback buttons can be used when searching for a part (page 74).

Important!

Selecting Start Point and End Point when Erasing a Part

- The first and last 5 seconds of a title to be edited cannot be selected as part erasure (start or end) points. If a start point is selected during the first 5 seconds from the start of a title, the start of the title becomes the start point. When the last 5 seconds from the end of a title is selected as a start point or end point, the point 5 seconds before the end of the title is selected as the start point or end point. When the end of a title has been selected, the end of a title is selected as the end point. In addition, when erasing 5 seconds before or after a chapter marker that has been automatically added during addition or erasure of a part as well, those parts cannot be selected as part erasure (start or end) points in the same manner as above.
- Once a specified range has been erased, it is completely erased. Since it cannot be restored to its prior state, use caution when erasing by checking the contents in advance.

Editing an Original Title



NOTE

- Start and end points may change slightly.
- When erasing a part, select a part that continues for at least 5 seconds. Parts of less than 5 seconds duration cannot be erased.
- In the case of increasing remaining recording time by erasing a part selected from an original title, erase a part that continues for at least 1 minute. In addition, a chapter marker is automatically inserted at the location of the erased part.
- Parts can be added or erased no more than 50 times for a single title.
- Discs on which parts have been added or erased more than 51 times for a single title with another DVD recorder can only be played back or initialized.

Inputting/Renaming the Title

DVD RW | DVD RW | DVD R
VR MODE | VIDEO MODE

When material is recorded, a title name that includes the date, time, channel number and other information is created automatically. You can change the title name to any name you desire. (The title name can no longer be changed once a disc recorded in the Video mode has been finalized.)

1 Press **EDIT** while the disc is stopped.

- The Original Edit Title List screen appears.

2 Press **▲/▼/◀/▶** to select the title and then press **SET/ENTER**.

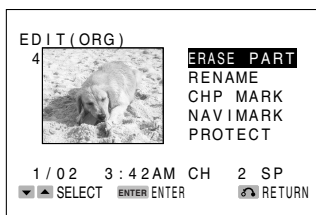

3 Press **▲/▼** to select “RENAME” and then press **SET/ENTER**.

4 Rename the title.

- ① Move the cursor to a character you want to change.
 - Press **▲/▼/◀/▶** to select “FWD” or “BACK” and then press **SET/ENTER** to move the cursor.

- ② Press **▲/▼/◀/▶** to select “DEL” and then press **SET/ENTER**.
 - Delete the character at the cursor position.
- ③ Press **▲/▼/◀/▶** to select a character you want to enter and then press **SET/ENTER**.
 - Enter the character at the cursor position.
- ④ Repeat the above step to change other characters.

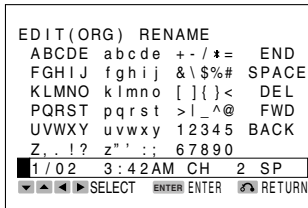

5 Press **▲/▼/◀/▶** to select “END” and then press **SET/ENTER** to fix the name.

6 Press **EDIT** to exit the edit mode.

NOTE

- Up to 24 characters can be entered.

Adding Chapter Markers

You can put a chapter marker anywhere in a title. (This function does not operate if the disc is recorded in Video mode.)

1 Press **EDIT** while the disc is stopped.

- The Original Edit Title List screen appears.

2 Press **▲/▼/◀/▶** to select the title and then press **SET/ENTER**.





Editing an Original Title



3 Press ▲ / ▼ to select “CHP MARK” and then press SET/ENTER.

- The selected title is played back.

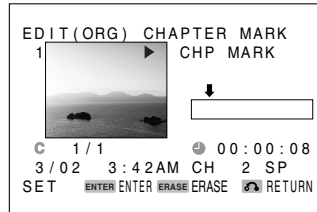

- Press ►PLAY, FWD►►, ◀◀REV, ■■STILL/PAUSE, SKIP►►, I◀◀SKIP, I►SLOW or SKIP SEARCH to find the point to put a chapter marker.

4 Press SET/ENTER to put a chapter marker.

- The material being played back pauses, and the added chapter marker is displayed in orange.

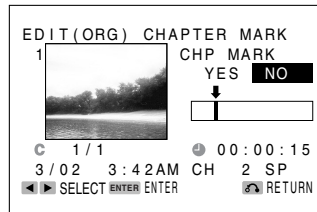

NOTE Intervals at which Chapter Markers are Added

- Leave an interval of at least 5 seconds between an existing chapter marker and the chapter marker that you want to add. A chapter marker cannot be added if this interval is too short.

5 Press ◀ to select “YES”.

- When you want to re-select the point, select “NO”. The screen in the step 3 appears.

6 Press SET/ENTER.

- The added chapter marker is displayed in blue.
- If you want to add another chapter marker, repeat steps 3 through 6.
- Pressing RETURN returns the operation to the screen described in step 2.

7 Press EDIT to exit the edit mode.

Erasing Chapter Markers

You can erase chapter markers that you no longer want. Chapter markers that have been added in the editing procedure (page 66) can be erased. Chapter markers that have been added automatically during the following procedures cannot be erased (chapter markers are displayed in red in step 4).

- Chapter markers that have been set automatically during recording
 - Chapter markers that have been added automatically when parts have been added or erased (pages 66 and 73)
- (Chapter markers cannot be erased from discs recorded in the Video mode.)

1 Press EDIT while the disc is stopped.

- The Original Edit Title List screen appears.

2 Press ▲/▼/◀/► to select the title and then press SET/ENTER.

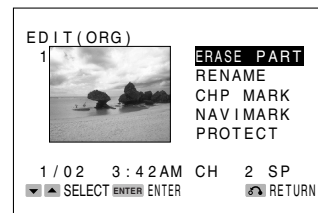

3 Press ▲ / ▼ to select “CHP MARK” and then press SET/ENTER.

- The selected title is played back.

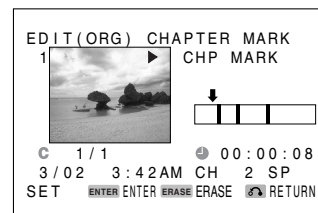

Editing an Original Title

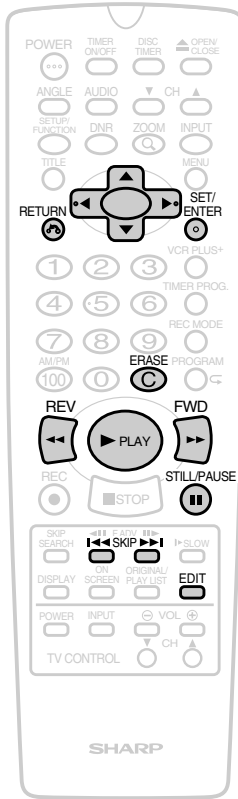

4 Playback the chapter (The marker is blue) that you want to erase.

- Press **▶PLAY, FWD▶▶**, **◀◀REV**, **■STILL/PAUSE**, **SKIP▶▶▶** or **◀◀SKIP** to find the point to erase a chapter marker.
- Red chapter markers cannot be selected.

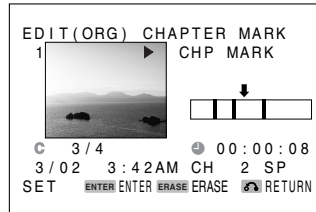

5 Press ERASE during playback the chapter.

- The material being played back returns to the start of the chapter, and the chapter marker turns orange.

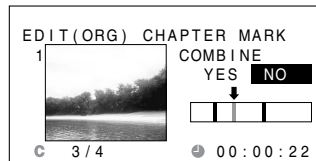

6 Press ◀ to select "YES".

- When you want to re-select the chapter marker, select "NO". The screen in the step 4 appears.

7 Press SET/ENTER.

- The chapter marker is erased and the part is connected to the previous chapter.
- If you want to add erase chapter mark, repeat steps 4 through 7.
- Pressing **RETURN** returns the operation to the screen described in step 2.

8 Press EDIT to exit the edit mode.

Navimark

DVD RW
VR MODE

In the DiscNavi, each title is shown with a still frame picture. You can select a different still picture from within a title.

1 Press EDIT while the disc is stopped.

- The Original Edit Title List screen appears.

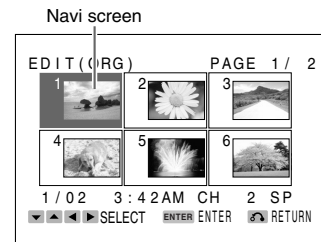

2 Press ▲/▼/◀▶ to select the desired title and then press SET/ENTER.



3 Press ▲/▼ to select "NAVIMARK" and then press SET/ENTER.

- The selected title is played back.

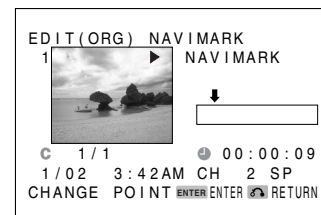



Editing an Original Title



4 Select the desired part displayed in the DiscNavi.

- Press **▶PLAY, FWD▶▶▶, ◀◀REV, ■■STILL/PAUSE, SKIP▶▶▶, ◀◀SKIP, ▶▶SLOW** or **SKIP SEARCH** to find the desired part.

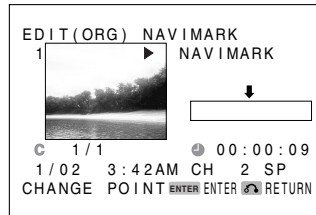

5 Press SET/ENTER at the point you want to set as Navimark.

- The material being played back pauses.

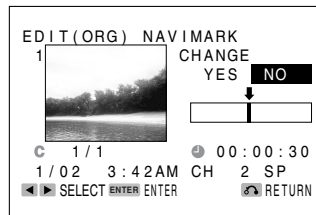

6 Press ◀ to select "YES".

- When you want to re-select the part, select "NO". The screen in the step 2 appears.

7 Press SET/ENTER.

- The screen in the step 2 appears.

8 Press EDIT to exit the edit mode.

Protecting the Title

DVD RW
VR MODE

This prevents disc contents from being edited or erased so that they cannot be altered by mistake. This is convenient for keeping discs safe during editing. (This function cannot be used with discs recorded in the Video mode.)

NOTE

- The protect function cannot be used in the case of playlists or discs recorded in the Video mode.

1 Press EDIT while the disc is stopped.

- The Original Edit Title List screen appears.

2 Press ▲/▼/◀/▶ to select the desired title and then press SET/ENTER.

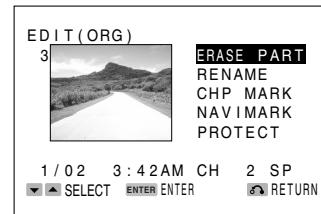

3 Press ▲/▼ to select "PROTECT" and then press SET/ENTER.

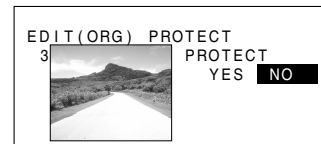

4 Press ◀ to select "YES" and then press SET/ENTER and press RETURN.

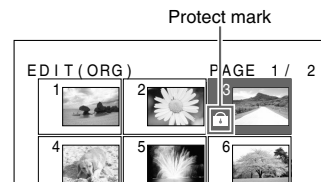

- A protect mark  is inserted in protected titles. (Protect marks can be confirmed on either the DiscNavi Title List screen or Edit Title List screen.)

5 Press EDIT to exit the edit mode.



Editing an Original Title

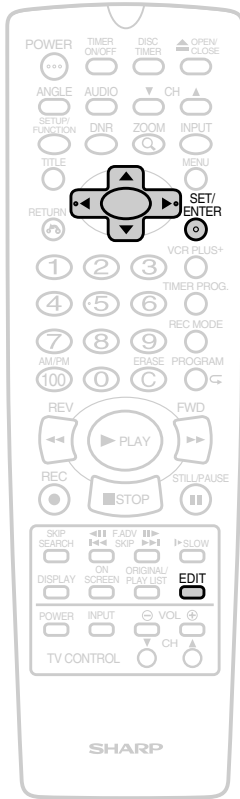

Canceling the Protection

NOTE

- A protect mark is attached to all titles when disc protect is set to "ON" in the "PROTECT" (page 88) of the "DISC SETUP" menu.
In this case, none of the titles can be unprotected. (Cancel disc protection in the "Disc Setup Screen" to unprotect discs.)

1 Press **EDIT** while the disc is stopped.

- The Original Edit Title List screen appears.

2 Press **▲/▼/◀/▶** to select the protected title and then press **SET/ENTER**.

3 Press **SET/ENTER**.

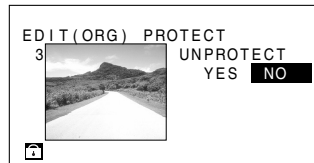

4 Press **◀** to select "YES" and then press **SET/ENTER**.

- Title protect is canceled and the protect mark is no longer displayed.

5 Press **EDIT** to exit the edit mode.

Erasing a Title from the Original or Playlist



Erasing All Titles

DVD RW | DVD RW | DVD R
VR MODE | VIDEO MODE | VIDEO MODE

This allows all Original or Playlist titles to be erased. (If a Playlist (page 72) has been created, all of the Playlist titles are erased if the Original title is erased.)

NOTE

Erasing all titles differs initialization in the ways indicated below.

- Titles which is protected are not erased.
- Disc timer recording programs are not erased.

1 Press ERASE while the disc is stopped.

- The Erase Title screen appears.

2 Press ORIGINAL/PLAY LIST to select Original or Playlist.

- Operation cannot be switched between Original and Playlist for a disc on which a Playlist has not been created.
- Discs recorded in the Video mode cannot contain Playlists.

ERASE TITLE (ORG)
1 TITLE
ALL TITLE

3 Press ▲ / ▼ to select "ALL TITLE" and then press SET/ENTER.

ERASE TITLE (ORG)
1 TITLE
ALL (EXCEPT PROTECT)
YES NO
CAREFUL OF
PLAYLIST

4 Press ◀ to select "YES" and then press SET/ENTER.

- All titles will be erased and then return to the normal screen.

NOTE

- About 2 minutes may be required for processing depending on the recording status of the disc, such as in the case the disc contains a lot of titles.

Erasing One Title

DVD RW | DVD RW | DVD R
VR MODE | VIDEO MODE | VIDEO MODE

This is used to erase a specific title by selecting that title. Since remaining recording time can be increased by erasing unnecessary titles, this function is convenient since it enables you to record repeatedly on the same disc.

- In the case of DVD-RW discs (Video mode), remaining recording time can only be increased by erasing the last title on the disc.
- Remaining recording time does not increase in the case of DVD-R discs.

In the case a Playlist has been created, the erased portions are no longer present when the Playlist is played back.

1 Perform the steps 1 and 2 of "Erasing All Titles" on this page.

- Pressing ERASE during playback changes the display to the screen of step 3, allowing you to erase the title currently being played back.

2 Press ▲ / ▼ to select "1 TITLE" and then press SET/ENTER.

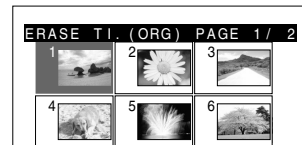

3 Press ▲ / ▼ / ◀ / ▶ to select the title you want to erase and then press SET/ENTER.



4 Press ◀ to select "YES" and then press SET/ENTER.

- The selected titles will be erased and then return to the screen in the step 2.

5 Press RETURN to exit the Erase Title screen.

- Press RETURN again to return to the normal screen.

NOTE

- Protected titles are not erased.
- The protect function is not available for Playlists and discs recorded in the Video mode.

Making a New Playlist (PL)



You can create a new Playlist by specifying the range of the material to be made into a Playlist from an Original. When specifying the range of a Playlist, the titles used for the Playlist have to be consecutive titles. DVD-RW discs recorded in the VR mode can be used to create Playlists. (Playlists cannot be created with DVD-R discs or DVD-RW discs recorded in the Video mode.) You can add up to 99 titles to the Playlist.

Making a Playlist from Original Title

DVD RW
VR MODE

One title of an Original can be used as the title of the Playlist. (The entire contents of the selected Original become the title of the Playlist.)

1 Press **EDIT** while the disc is stopped.

- The Original Edit Title List screen appears.

2 Press **ORIGINAL/PLAY LIST** to select Playlist mode.

- The Playlist Edit Title List screen appears.

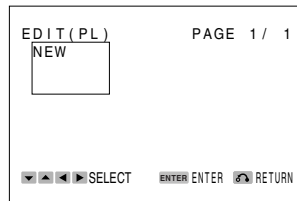

- Since a title does not exist at this point, a title frame that does not contain a picture is displayed.
- Select a title frame that does not contain a picture when creating a new Playlist.

3 Press **SET/ENTER**.

- The Playlist Make screen appears.

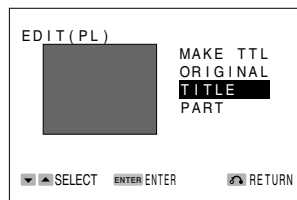

4 Press **▲/▼** to select "TITLE" and then press **SET/ENTER**.

- The Original Navi screen appears.

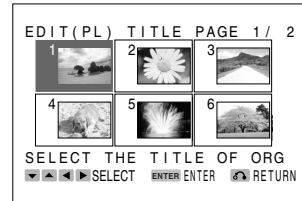

5 Press **▲/▼/◀/▶** to select the title you want to copy and then press **SET/ENTER**.

- A new Playlist is created.

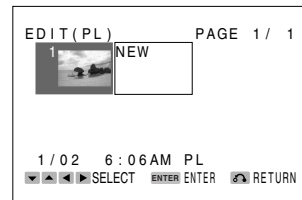

NOTE

- The operation of copying a title does not actually copy the title of the Original, but rather writes information indicating that the Original title is to be used as the title of the Playlist. Consequently, editing can be performed without reducing available space on the disc.
- Only chapter markers automatically created at the start of recording and erasure of a part are copied.
- When creating a Playlist from an Original title, Navimark information has been changed or the title name of the Original title is not copied.
- Chapter markers that have been copied to a Playlist cannot be erased.



Making a New Playlist (PL)



Adding a Part to the Playlist

DVD RW
VR MODE

You can select part of an Original title as a new title to add to the Playlist.

1 Press **EDIT** while the disc is stopped.

- The Original Edit Title List screen appears.

2 Press **ORIGINAL/PLAY LIST** to select Playlist mode.

- The Playlist Edit Title List screen appears.

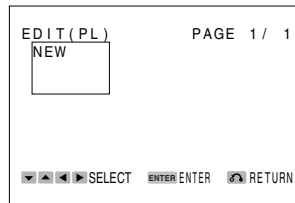

- Since a title does not exist at this point, a title frame that does not contain a picture is displayed.
- Select a title frame that does not contain a picture when creating a new Playlist.

3 Press **SET/ENTER**.

- The Playlist Make screen appears.

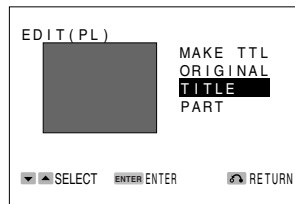

4 Press **▲/▼** to select "PART" and then press **SET/ENTER**.

- The Original title is played back.



5 Press **SET/ENTER** to set the start point of the part.

- Press **▶PLAY, FWD▶▶**, **◀◀REV**, **■STILL/PAUSE, SKIP▶▶**, **◀◀SKIP, ▶▶SLOW** or **SKIP SEARCH** to find the start point.

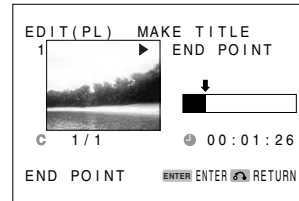

6 Press **SET/ENTER** to set the end point of the part.



NOTE

- When copying a part, make sure to select a part that continues for at least 5 seconds. Parts of less than 5 seconds duration cannot be copied.

Resetting Start point and End Point

- Until you have actually set the range, the start point and end point can be reset. After going back to setting the start point and end point by pressing **RETURN**, perform step 5 or step 6 to reselect the part.

7 Press **◀** to select "YES" to confirm the part.

Making a New Playlist (PL)



8 Press **SET/ENTER**.

- The part is played back from the start point to the end point.
- If you select “NO” in the step 7, go to step 9.



9 Press **◀** to select “YES” and then press **SET/ENTER**.

- The new title appears in the updated Playlist.

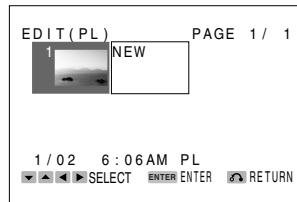

● **Pause**

When you have found a part that is close to the start point or end point, press **STILL/PAUSE**. Pausing playback makes it easier to search for parts. Parts cannot be edited in exact frames. The start point and end point may shift slightly.

● **Frame advance/Frame reverse**

Recorded material is played back by reversing individual frames when **F.ADV** is pressed after pausing the part. When **◀F.ADV** is pressed, recorded material is played back while reversing individual frames. (There is an error of 2-3 frames during frame advance playback.)

● **Final selection of part**

Press **▶SLOW** after the part has been paused and select the start point and end point by slow playback.

Searching for Start Point and End Point Parts

You can use the procedures described below during playback to search for the start point and end point parts.

● **Playback**

Press **▶PLAY** to playback the current title that is paused.

● **Searching for parts within a chapter**

FWD▶▶ or **◀◀REV** are convenient when searching for parts within a chapter.

● **Rapidly skipping parts**

When the editing screen is displayed, pressing **SKIP SEARCH** lets you skip by recorded material at 5 minute intervals, which is convenient for rapidly moving through parts. This can be pressed consecutively up to 4 times, enabling you to skip 20 minutes of recorded material all at once.

Only use the skip function within the same title.

● **Moving to the start of titles and chapters**

When currently viewing a title or chapter that is far away from the part to be selected, first search for the title or chapter with the **◀◀SKIP** or **SKIP▶▶**.

Editing a Playlist Title



Erasing a Part from the Playlist

DVD RW
VR MODE

You can erase a part from the Playlist. If you erase a part, nothing is actually erased from the Original title.

1 Press **EDIT** while the disc is stopped.

- The Original Edit Title List screen appears.

2 Press **ORIGINAL/PLAY LIST** to select **Playlist mode**.

- The Playlist Edit Title List screen appears.

3 Perform the steps 2 to 8 of “Erasing a Part from the Original” on page 65.

NOTE

- A chapter marker is inserted automatically when a part has been erased.
- Since editing cannot be performed in exact frames, the start point and end point may shift.
- When erasing a part, select a part that continues for at least 5 seconds. Parts of less than 5 seconds duration cannot be erased.
- Parts can be added or erased up to 50 times per title.

! Important!

- The first and last 5 seconds of a title to be edited cannot be selected as part erasure (start or end) points. If a start point is selected during the first 5 seconds from the start of a title, the start of the title becomes the start point. When the last 5 seconds from the end of a title is selected as a start point or end point, the point 5 seconds before the end of the title is selected as the start point or end point. When the end of a title has been selected, the end of a title is selected as the end point. In addition, when erasing 5 seconds before or after a chapter mark that has been automatically added during addition or erasure of a part as well, those parts cannot be selected as part erasure (start or end) points in the same manner as above.

Moving the Title

DVD RW
VR MODE

You can change the playing order of Playlist titles.

1 Press **EDIT** while the disc is stopped.

- The Original Edit Title List screen appears

2 Press **ORIGINAL/PLAY LIST** to select **Playlist mode**.

- The Playlist Edit Title List screen appears.

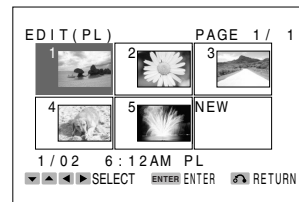

3 Press **▲/▼/◀/▶** to select the title and then press **SET/ENTER**.

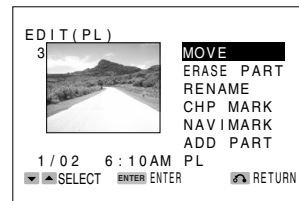

4 Press **▲/▼** to select “**MOVE**” and then press **SET/ENTER**.

5 Press **▲/▼/◀/▶** to select the place you want to move the title.



Editing a Playlist Title



6 Press SET/ENTER.

- When having selected a destination that is before a selected file, the file moves to the destination immediately before the selected title.

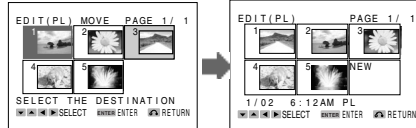

Example: When Title 3 has been selected and the destination cursor is placed at Title 1, Title 3 moves before Title 1.

- When having selected a destination that is after a selected file, the file moves to the destination immediately after the selected title.

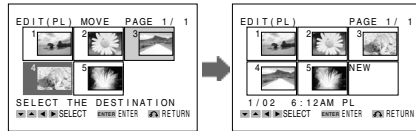

Example: When Title 3 has been selected and the destination cursor is placed at Title 4, Title 3 moves after Title 4.

7 Press EDIT to exit the edit mode.

Adding a Part from the Original to the Playlist

DVD RW
VR MODE

A part selected from an Original is added to the end of the Playlist title.

1 Press EDIT while the disc is stopped.

- The Original Edit Title List screen appears.

2 Press ORIGINAL/PLAY LIST to select Playlist mode.

- The Playlist Edit Title List screen appears.

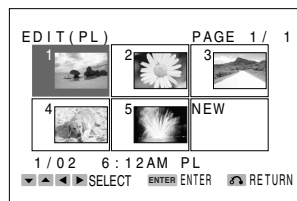

3 Press ▲/▼/◀/▶ to select the title and then press SET/ENTER.

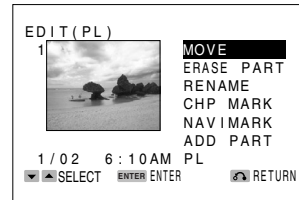

4 Press ▲ / ▼ to select "ADD PART" and then press SET/ENTER.

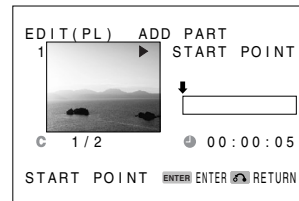

5 Press SET/ENTER to set the start point of the part.

- Press ►PLAY, FWD►►, ◀◀REV, ■■STILL/PAUSE, SKIP►►, I◀◀SKIP, ►SLOW or SKIP SEARCH to find the start point.
- The Original title is played back.

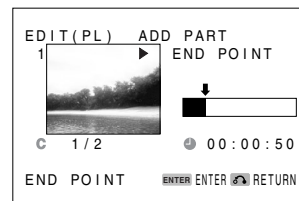



Editing a Playlist Title



6 Press **SET/ENTER** to set the end point of the part.

NOTE

- When erasing a part, select a part that continues for at least 5 seconds. Parts of less than 5 seconds duration cannot be erased.
- Parts can be added or erased up to 50 times per title.
- The start point is canceled when **◀◀REV** or **I◀◀SKIP** is pressed to go back to before the start point after the start point has been set.
- Some playback buttons can be used when searching for a part (page 74).
- Until you have actually set the range, the start point and end point can be reset. After going back to setting the start point and end point by pressing **RETURN**, perform step 5 or step 6 to reselect the part.

7 Press **◀** to select "YES".



8 Press **SET/ENTER**.

- The part is played back from the start point to the end point.



- You can test playback the range from the added start point to the added end point.
- It may take up to about 1 minute until the confirmation screen is displayed.

9 Press **◀** to select "YES" and then press **SET/ENTER**.

- The part is added to the end of Playlist 1.
- The screen in the step 4 appears.

10 Press **EDIT** to exit the edit mode.

NOTE

- A chapter marker is automatically inserted at the start point where the part was added.
- Discs on which parts have been added or erased more than 51 times for a single title with another DVD recorder can only be played back or initialized.

Adding Chapter Marker in a Playlist



You can put a chapter marker anywhere in a title.

1 Press **EDIT** while the disc is stopped.

- The Original Edit Title List screen appears.

2 Press **ORIGINAL/PLAY LIST** to select Playlist mode.

- The Playlist Edit Title List screen appears.

3 Perform the steps 2 to 7 of "Adding Chapter Markers" on page 66.

- The procedure is the same for addition of chapter markers of Original recordings.

NOTE

When adding chapter markers during editing:

- Allow an interval of at least 5 seconds between a chapter marker and the chapter marker you want to add. A chapter marker cannot be added if this interval is too short.

Editing a Playlist Title



Erasing Chapter Marker in a Playlist

- 1 Press EDIT while the disc is stopped.**
 - The Original Edit Title List screen appears
- 2 Press ORIGINAL/PLAY LIST to select Playlist mode.**
 - The Playlist Edit Title List screen appears.
- 3 Perform the steps 2 to 8 of “Erasing Chapter Marker” on page 67.**

NOTE

The following chapter markers cannot be erased. These chapter markers are displayed in red on the Chapter Erase screen (page 68, step 4).

- Chapter markers that have been inserted automatically when recording is started.
- Chapter markers that have been added automatically after adding a part.
- Chapter markers that have been added automatically after erasing a part.

Navimark

DVD RW |
VR MODE

- 1 Press EDIT while the disc is stopped.**
 - The Original Edit Title List screen appears.
- 2 Press ORIGINAL/PLAY LIST to select Playlist mode.**
 - The Playlist Edit Title List screen appears.
- 3 Perform the steps 2 to 8 of “Navimark” on page 68.**

Renaming the Title

DVD RW |
VR MODE

- 1 Press EDIT while the disc is stopped.**
 - The Original Edit Title List screen appears
- 2 Press ORIGINAL/PLAY LIST to select Playlist mode.**
 - The Playlist Edit Title List screen appears.
- 3 Perform the steps 2 to 6 of “Inputting/Renaming the Title” on page 66.**

Tamper Proof

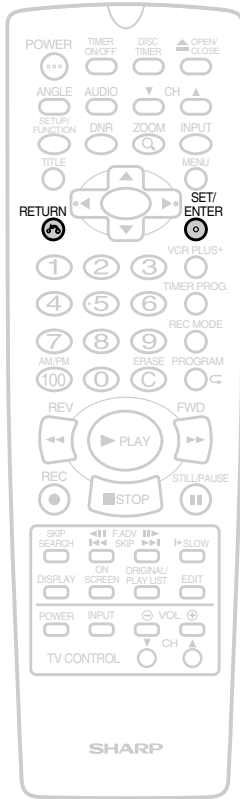

With this feature, you can lock all recorder modes to prevent accidental change. This function works even when the recorder power is off, thus preventing children from operating the recorder or viewing selected programs while you are away from home.

Tamper Proof Setting



Press and hold **SET/ENTER** and **RETURN** together for more than 2 seconds.

- "Ⓢ" on the Front Panel Display starts blinking and then lights up.



Disengaging Tamper Proof

Press and hold **SET/ENTER** and **RETURN** together for more than 2 seconds when the Tamper Proof function is set.

- "Ⓢ" starts blinking and then disappears. Now, Tamper Proof is disengaged.

Operating during Tamper Proof

"Ⓢ" on the Front Panel Display is blinking.



NOTE

- This function does not work when the disc tray is opened.
- If an unplayable disc is loaded, the disc tray slides out automatically and then Tamper Proof function is disengaged.

Playback Setup Screen

This section explains each item of playback setup. See "Basic Settings of the Playback Setup Screen" on page 82 to set each item.

TV MODE

This lets you set whether you want to view played back material at an aspect ratio of 16:9 for wide screen TVs or at an aspect ratio of 4:3 for conventional TVs. (This setting is made to match the TV connected to this recorder.)

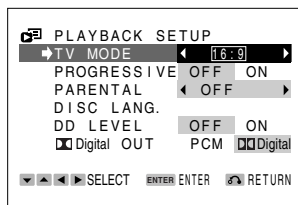

- **4:3 PS** — (Pan & Scan mode): When wide-screen video material is played, this mode clips the right and left sides of the image so that it can be viewed on a conventional TV screen.
 - Some wide-screen DVDs that do not permit Pan & Scan mode playback are automatically played in letterbox mode (black bands top and bottom).
- **4:3 LB** — (Letterbox mode): When wide-screen video material is played in this mode on a conventional TV screen, black bands appear at the top and bottom of the screen.
- **16:9** — (Wide-screen TV): This is the correct mode for playing wide-screen videos on a wide-screen TV.
 - You must also set the screen mode on your wide-screen TV to "FULL".

NOTE

When recording wide screen material (16:9) from a satellite broadcast in the Video mode:

- The screen becomes longer in the vertical direction when playing back with this recorder or another DVD player and viewing on a normal (4:3) TV.
- The screen also becomes longer in the vertical direction when playing back with a PC capable of playing back DVD video. (The output is set at 16:9 regardless of the TV screen setting during playback.)

When recording wide screen material (16:9) from a satellite broadcast in the VR mode:

- When playing back with this recorder and viewing with a normal (4:3) TV, the screen size during playback can be changed according to the setting for "TV MODE" of "PLAYBACK SETUP". However, if the recording mode of the disc is set to LP or EP, the material will be played back in "4:3 LB" even if "TV MODE" of "PLAYBACK SETUP" is set to "4:3 PS".

PROGRESSIVE

Clearer images containing minimal flickering can be enjoyed when playing back discs by connecting a progressive-compatible TV with a component.

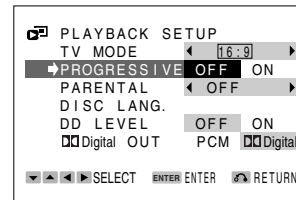

ON

Set when the recorder is connected to a progressive-compatible TV.

- The screen may not switch to a 4:3 screen during progressive material depending on the TV you are using. If you want to view material on a 4:3 screen with such TVs, set "PROGRESSIVE" to "OFF".

Compatibility of this recorder with Progressive-compatible TVs:

- Since some progressive-compatible TVs are currently not completely compatible with this recorder, there may be times when images may not appear clearly. If a problem occurs during progressive playback, set "PROGRESSIVE" to "OFF".

OFF

Set when the recorder is connected to a TV that is not progressive-compatible.

- When the recorder is connected to a TV that is not progressive-compatible and "PROGRESSIVE" is set to "ON", there is no video output.

NOTE

- The DV output cannot be used during progressive playback.



Playback Setup Screen

PARENTAL

Certain discs come preset with country codes and parental level settings defined for particular countries.

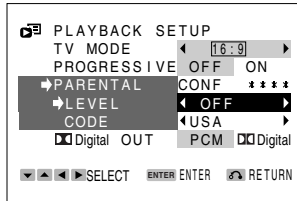

See "PARENTAL Level Setting" on page 82 for details.

DISC LANG.

Use this setting for selecting "SUBTITLE", "AUDIO" and "MENU".

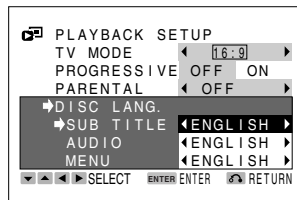

● SUBTITLE

The language that has been set is your preferred subtitle language.

● AUDIO

The language that has been set is your preferred audio language.

● MENU

- The language that has been set is your preferred menu language.
- Disc language changes as follows:
 - "ENGLISH" → "FRENCH" → "GERMAN" → "ITALIAN"
 - "SPANISH" → "CHINESE" → "SWEDISH" →
 - "DUTCH" → "OTHER:AA...ZU"
- If you select "OTHER", see "Language Code List for Disc Language" on page 85 when selecting the code.

See "DISC LANGUAGE Setting" on page 84 for details.

DD LEVEL (Dolby Digital Output Level)

When Dolby Digital is used to record the audio on a DVD disc, the average overall volume level of the audio is relatively lower than that produced by an Audio CD. This is to provide the widest possible dynamic range. To counteract this, this recorder automatically raises the overall average volume level of a disc recorded using Dolby Digital to a level that is similar to that of an Audio CD.

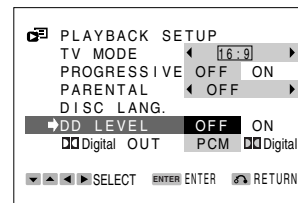

ON: Dolby Digital average audio level is increased so it sounds similar to that of an Audio CD.

OFF: Audio level recorded on disc is played back without modification.

Digital OUT

Use this setting to enjoy Dolby Digital Surround audio by making a digital connection with equipment provided with a digital input jack.

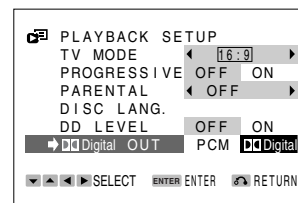

● PCM

PCM audio can be enjoyed by making a digital connection with 2 channel audio equipment and MD players. Dolby Digital audio is output in the form of PCM (non-compressed) audio that can be played back with 2 channel audio equipment.

● Digital

You can enjoy Dolby Surround audio by making a digital connection with audio equipment compatible with Dolby Digital (5.1 ch). DTS audio can be enjoyed by connecting with an amplifier or other equipment compatible with DTS Digital Surround.

Playback Setup Screen



Basic Settings of the Playback Setup Screen

DVD VIDEO DVD RW DVD RW DVD R
VR MODE VIDEO MODE

NOTE

- During playback, you cannot set each item in the SETUP screen. Press **STOP** to stop playback.

Example: Set "PROGRESSIVE" to "ON"

1 Press **SETUP/FUNCTION** to display the **SETUP** screen.

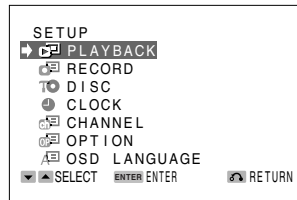

2 Press **▲ / ▼** to select "PLAYBACK" and then press **SET/ENTER**.

- The PLAYBACK SETUP screen appears.

3 Press **▲ / ▼** to select "PROGRESSIVE".

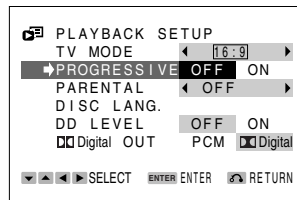

4 Press **◀ / ▶** to select "ON".

5 Press **SET/ENTER** to confirm the setting.

- You can exit the SETUP screen by pressing **SETUP/FUNCTION**.

PARENTAL Level Setting

DVD VIDEO

Certain discs come preset with country codes and parental level settings defined for particular countries. Discs equipped with the parental lock function are rated according to their content. The rated content allowed by a parental lock level and the way a DVD can be controlled vary from disc to disc. Some discs, for example, may let you edit out parts and replace them with parts suitable for children. You can also use the parental lock to completely disable playback of the DVD.

1 Press **SETUP/FUNCTION** to display the **SETUP** screen.

2 Press **▲ / ▼** to select the "PLAYBACK" and then press **SET/ENTER**.

- The PLAYBACK SETUP screen appears.

3 Press **▲ / ▼** to select "PARENTAL".

4 Press **◀ / ▶**.

- The password specification and verification screen appears.

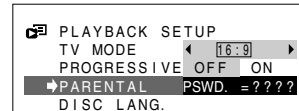

- If you have already set your password, (password verification display) appears.
- Press **RETURN** to return to the previous screen.

5 Use the number buttons to enter a 4-digit password.

- When you set the password for the first time, enter the same password again. The password will be automatically stored.

NOTE

- Enter the numbers slowly as each number is stored separately.

If you forget your password, you can erase your current password by pressing **STOP** four times.



Playback Setup Screen



6 The cursor is moved to “LEVEL” and then press ◀/▶ to select “LEVEL”.

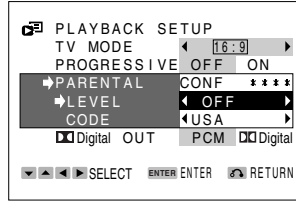

- Level 1: for most restricted viewing → Level 8: for adult viewing (The smaller the number, the greater the level of restriction.)
- When “PARENTAL” is set to “OFF”, DVD discs can be played back regardless of the parental level.

The parental level for U.S.A. is as follows.

Level 7: NC-17 Level 6: R Level 4: PG13
Level 3: PG Level 1: G

The parental level set up for Canada is prepared for future use. As for the set up of an appropriate level, please check the level when you purchase your DVD disc equipped with the parental feature.

7 Press ▲/▼ to select “CODE”.

8 Press ◀/▶ to select the desired country code.

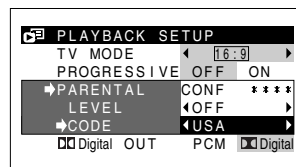

9 Press **SET/ENTER** to confirm the setting.

- Press **SETUP/FUNCTION** to exit the SETUP screen.

! Important!

- Be sure to try playing back the disc to confirm that the parental level setting is working correctly. If it is not working correctly, try changing the country code.

NOTE

- You can use the parental lock function only with DVD discs that are equipped with the parental lock feature.
- On some DVD discs, the PARENTAL level setting is fixed and cannot be modified.
- The parental level depends on countries. If you do not set the country code correctly, it fails to work correctly.
- Some DVD discs allow the viewer to temporarily change the parental level setting to view the original scenes. When this prompt appears, input the password to view the original scenes.

Country Code List

USA	FINLAND
CANADA	BELGIUM
JAPAN	HONG KONG
GERMANY	SINGAPORE
FRANCE	THAILAND
UK	MALAYSIA
ITALY	INDONESIA
SPAIN	TAIWAN
SWISS	PHILIPPINE
SWEDEN	AUSTRALIA
HOLLAND	RUSSIA
NORWAY	CHINA
DENMARK	—

Playback Setup Screen



DISC LANGUAGE Setting

DVD VIDEO

NOTE

- During playback, you cannot set each item in the SETUP screen. Press **STOP** to stop playback.

Example: Setting "SUBTITLE"

1 Press **SETUP/FUNCTION** to display the **SETUP** screen.

2 Press **▲ / ▼** to select "**PLAYBACK**" and then press **SET/ENTER**.

- The **PLAYBACK SETUP** screen appears.

3 Press **▲ / ▼** to select "**DISC LANG.**" and then press **▶**.

Example: Selecting "SUBTITLE"

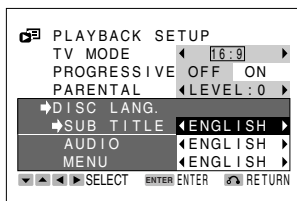

4 Press **▲ / ▼** to select "**SUB TITLE**".

5 Press **◀ / ▶** to select the language you want to use.

NOTE

- Disc language changes as follows:
"ENGLISH" → "FRENCH" → "GERMAN" → "ITALIAN" → "SPANISH" → "CHINESE" → "SWEDISH" → "DUTCH" → "OTHER:AA...ZU"
- If you select "OTHER", see "Language Code List for Disc Language" on page 85 when selecting the code.

6 Press **SET/ENTER** to confirm the setting.

- You can set "AUDIO" and "MENU" the same way.
- Press **SETUP/FUNCTION** to exit the SETUP screen.

Language Code List for Disc Language

Code	Language Name	Code	Language Name	Code	Language Name	Code	Language Name
AA	Afar	FY	Frisian	MG	Malagasy	SL	Slovenian
AB	Abkhazian	GA	Irish	MI	Maori	SM	Samoan
AF	Afrikaans	GD	Scots Gaelic	MK	Macedonian	SN	Shona
AM	Ameharic	GL	Galician	ML	Malayalam	SO	Somali
AR	Arabic	GN	Guarani	MN	Mongolian	SQ	Albanian
AS	Assamese	GU	Gujarati	MO	Moldavian	SR	Serbian
AY	Aymara	HA	Hausa	MR	Marathi	SS	Siswat
AZ	Azerbaijani	HI	Hindi	MS	Malay	ST	Sesotho
BA	Bashkir	HR	Croatian	MT	Maltese	SU	Sundanese
BE	Byelorussian	HU	Hungarian	MY	Burmese	SV	Swedish
BG	Bulgarian	HY	Armenian	NA	Nauru	SW	Swahili
BH	Bihari	IA	Interlingua	NE	Nepali	TA	Tamil
BI	Bislama	IE	Interlingue	NL	Dutch	TE	Telugu
BN	Bengali; Bangla	IK	Inupiak	NO	Norwegian	TG	Tajik
BO	Tibetan	IN	Indonesian	OC	Occitan	TH	Thai
BR	Breton	IS	Icelandic	OM	(Afan) Oromo	TI	Tigrinya
CA	Catalan	IT	Italian	OR	Oriya	TK	Turkmen
CO	Corsican	IW	Hebrew	PA	Panjabi	TL	Tagalog
CS	Czech	JA	Japanese	PL	Polish	TN	Setswana
CS	Czech	JL	Yiddish	PS	Pashto, Pushto	TO	Tonga
CY	Welsh	JW	Javanese	PT	Portuguese	TR	Turkish
DA	Danish	KA	Georgian	QU	Quechua	TS	Tsonga
DE	German	KK	Kazakh	RM	Rhaeto- Romance	TT	Tatar
DZ	Bhutani	KL	Greenlandic	RN	Kirundi	TW	Twi
EL	Greek	KM	Cambodian	RO	Romanian	UK	Ukrainian
EN	English	KN	Kannada	RU	Russian	UR	Urdu
EO	Esperanto	KO	Korean	RU	Russian	UZ	Uzbek
ES	Spanish	KS	Kashmiri	RW	Kinyarwanda	VI	Vietnamese
ET	Estonian	KU	Kurdish	SA	Sanskrit	VO	Volapük
EU	Basque	KY	Kirghiz	SD	Sindhi	WO	Wolof
FA	Persian	LA	Latin	SG	Sangho	XH	Xhosa
FI	Finnish	LN	Lingala	SH	Serbo- Croatian	YO	Yoruba
FJ	Fiji	LO	Laothian	SI	Singhalese	ZH	Chinese
FO	Faroese	LT	Lithuanian	SK	Slovak	ZU	Zulu
FR	French	LV	Latvian, Lettish				

Record Setup Screen

This section explains each item of record setup. See "Basic Settings of the Record Setup Screen" on page 87 to set each item.

CHP INT.

This is used to set the interval at which chapters are automatically inserted when recording in the Video mode.

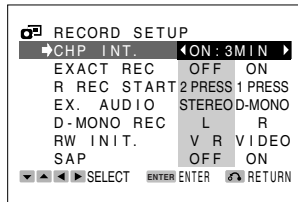

ON: 3 MIN	ON: 5 MIN	ON: 10 MIN	ON: 15 MIN	ON: 30 MIN	OFF
Every 3 minutes	Every 5 minutes	Every 10 minutes	Every 15 minutes	Every 30 minutes	OFF

* When "EXACT REC" has been set to "ON", the auto chapter interval becomes a little shorter (by a maximum of 1 minute).

EXACT REC

This function prevents a recording from ending out before it is completed by automatically changing the recording mode when timer recording (including VCR Plus+, timer recording and disc timer recording) is unable to be completed in the set recording mode due to insufficient time or available disc space. (There may be times when considerable amount of disc space remains available compared to recording time.)

- The EXACT REC function is activated when, during the course of recording in the programmed order, the next program is unable to be completely recorded due to insufficient available disc space in the set recording mode.
- When the available disc space is extremely small low, the recording may not be able to be completed even if the EXACT REC function has been set.
- The EXACT REC function is not available during Simple Recording Timer (page 51).
- The EXACT REC function is not activated during timer recording in the VR mode when the recording mode has been set to EP, or during timer recording in the Video mode when the recording mode has been set to LP.

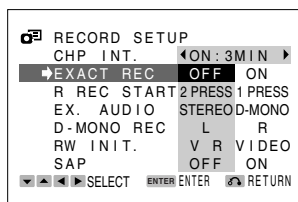

- **OFF:** Recording continues in the recording mode set during timer recording programming.
- **ON:** The recording mode is changed automatically during timer recording to prevent the recording from ending before it is completed.

R REC START

When recording using a DVD-R disc, you need to press **REC** twice.

You can change this if you prefer DVD-R recording to work in the same way as recording to DVD-RW. This function is factory preset to "2 PRESS".

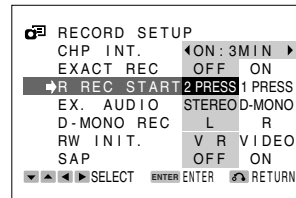

EX. AUDIO

Select the sound input from the external source.

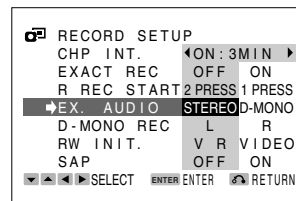

- **STEREO:** Recording standard stereo sound.
- **D-MONO:** Recording the sound that each channel carries as a separate sound.

D-MONO REC

When recording an external source in Video mode, you can select the sound to record either "L" (left) or "R" (right) audio channel.

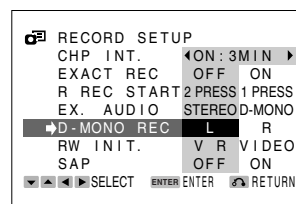

* This does not apply if recording from the DV input.

RW INIT.

When you load a new DVD-RW disc, the recorder starts initializing automatically. You can select to initialize for RW mode or Video mode.

* This function works only on DVD-RW discs.

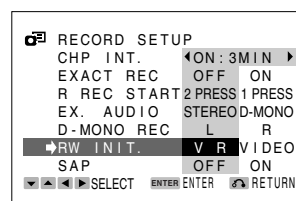

- **VR:** Initialize a disc for VR mode automatically
- **VIDEO:** Initialize a disc for Video mode automatically



Record Setup Screen



SAP

This recorder can record stereo or SAP (Separate Audio Program) broadcasts, where available. If the broadcast is in stereo, the recorder automatically records the stereo sound. If the broadcast is in SAP, you can record both the MAIN and the SAP mode to ON. If the broadcast is in stereo/SAP, you can record either the SAP sound by using the menu screen to set the SAP mode to ON, or stereo sound by setting the SAP mode to OFF.



SAP Broadcast

The monitor output listed in the table shows the audio output mode. The contents of audio recording are different VR mode and Video mode. See the table below for details.

Broadcast Received/SAP ON or OFF	AUDIO Mode	Recording		AUDIO OUTPUT	
		L	R	L	R
STEREO+SAP	MONO	L+R	L+R	L+R	L+R
SAP OFF	L R	L	R	L	R
STEREO+SAP	MONO	L+R	L+R	L+R	L+R
SAP ON	L R	L+R	SAP	SAP	SAP
STEREO	MONO	L+R	L+R	L+R	L+R
SAP OFF	L R	L	R	L	R
STEREO	MONO	L+R	L+R	L+R	L+R
SAP ON	L R	L	R	L	R
MONO+SAP	MONO	MONO	MONO	MONO	MONO
SAP OFF	L R	MONO	MONO	MONO	MONO
MONO+SAP	MONO	MONO	MONO	MONO	MONO
SAP ON	L R	MONO	SAP	SAP	SAP
MONO	MONO	MONO	MONO	MONO	MONO
SAP OFF	L R	MONO	MONO	MONO	MONO
MONO	MONO	MONO	MONO	MONO	MONO
SAP ON	L R	MONO	MONO	MONO	MONO

□: When recording in Video mode, the SAP channel is recorded on this channel.

Basic Settings of the Record Setup Screen

DVD RW VR MODE DVD RW VIDEO MODE DVD R

NOTE

- During playback, you cannot set each item in the SETUP screen. Press **STOP** to stop playback.

Example: Set "EXACT REC" to "ON"

- Press **SETUP/FUNCTION** to display the SETUP screen.

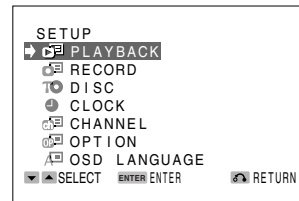

- Press **▲ / ▼** to select "RECORD" and then press **SET/ENTER**.

- The RECORD SETUP screen appears.
- Press **RETURN** to return to the previous screen.

- Press **▲ / ▼** to select "EXACT REC".

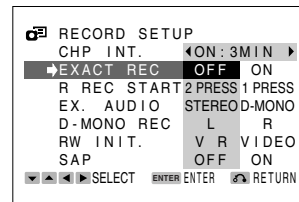

- Press **◀ / ▶** to select "ON" and then press **SET/ENTER**.

- Press **SETUP/FUNCTION** to exit the SETUP screen.

Disc Setup Screen

This section explains each item of disc setup. See "Basic Settings of the Disc Setup Screen" on page 89 to set each item.

VR MODE INITIALIZE

When you record on a DVD-RW disc in VR mode, you need to initialize the disc in VR mode.

(This is used when you want to erase the entire contents of a recorded disc. Check the recorded contents before erasing so that disc contents are not erased by mistake.)

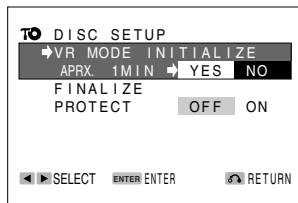

- * This function does not work when the disc is protected.
- * You cannot initialize DVD-R discs for VR mode.

VIDEO MODE INITIALIZE

When a DVD-RW disc is used to record in the Video mode, the disc must be initialized in the Video mode before you start recording. Initializing is also used to erase the entire contents of a recorded disc (contents cannot be erased from DVD-R discs).

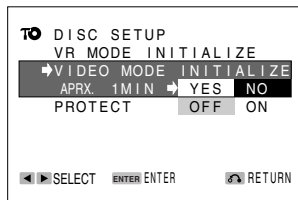

- * DVD-R discs cannot be initialized.

FINALIZE

- When a disc recorded in the Video mode is played back with another DVD player or when a disc recorded in the VR mode is not played back with another DVD-RW-compatible player, finalize the disc so that it can be played back.
- Several minutes to about 1 hour may be required for finalizing processing. (Processing takes longer time when there is a large amount of available disc space on DVD-RW discs (VR mode).)

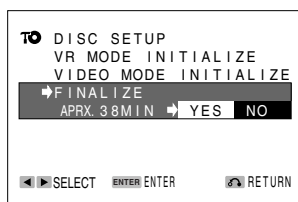

- Once a disc has been finalized with this recorder, it does not have to be finalized again.
- Discs in the VR mode that have been finalized with this recorder can be recorded and edited even after they have been finalized.
- A disc menu is generated for discs in the Video mode that have been finalized with this recorder. Discs that have been finalized cannot be used for recording or editing.
- Finalizing cannot be selected when a finalized disc has been loaded in the recorder. When a DVD-RW disc (VR mode) that has been finalized with a different recorder is loaded in this recorder, "UNDO FINALIZE" may be displayed. The disc can be used for recording and editing with this recorder if Undo Finalize is performed at this time.
- Finalizing of VR mode discs can be interrupted even when finalizing is in progress. However, starting about 4 minutes before completion of finalizing, the interrupt display is no longer displayed, indicating that finalizing can no longer be interrupted. In addition, finalizing can also not be interrupted if the interrupt display is not displayed from the start of finalizing.

PROTECT

This lets you protect a recorded disc. Disc protect prevents the contents of that disc from being altered by recording or editing. In addition, this procedure is used to cancel disc protect. Once disc protect is canceled, it can again be used for recording and editing.

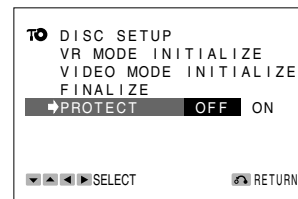

- **OFF:** Disc protect is canceled and the disc can be used for editing and recording.
 - **ON:** Disc protect is activated and the disc cannot be edited or recorded.
- * Discs for which disc protect has been set cannot be initialized.
- * Disc protect is only available for DVD-RW discs (VR mode).
- * Protect processing may take up to about 2 minutes depending on the recording status of the disc such as if the disc contains a large number of titles.



Disc Setup Screen



Basic Settings of the Disc Setup Screen

DVD RW VR MODE DVD RW VIDEO MODE DVD R

NOTE

- During playback, you cannot set each item in the SETUP screen. Press **STOP** to stop playback.

Example: Select "VR MODE INITIALIZE"

1 Press **SETUP/FUNCTION** to display the **SETUP** screen.

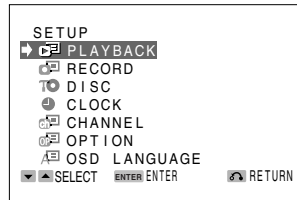

2 Press **▲/▼** to select "DISC" and then press **SET/ENTER**.

- The DISC SETUP screen appears.
- Press **RETURN** to return to the previous screen.



3 Press **▲/▼** to select "VR MODE INITIALIZE" and then press **▶**.

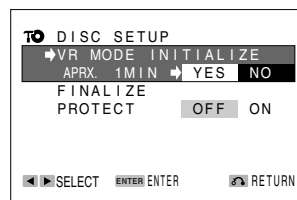

4 Press **◀** to select "YES" and then press **SET/ENTER**.

- The initializing starts.

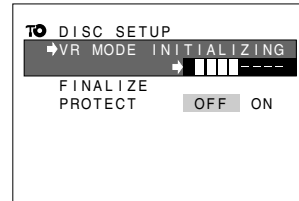

- The screen in step 2 appears after initializing.
- Press **SETUP/FUNCTION** to exit the SETUP screen.

Option Setup Screen

This section explains each item of option setup. See "Basic Settings of the Option Setup Screen" on page 92 to set each item.

CLOCK DISP

This function turns on or off the clock indicator on the Front Panel Display to save electricity when the recorder is turned off.

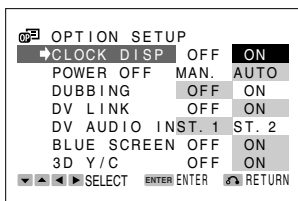

- **OFF:** Turns off the clock indicator on the Front Panel Display to save electricity when the recorder is turned off. The STANDBY indicator lights up when the recorder is turned off.
- **ON:** Turns on the clock indicator on the Front Panel Display when the recorder is turned off.

POWER OFF

When you forget to turn off power or do not operate the recorder, the power is turned off automatically about 3 hours later to save electricity.

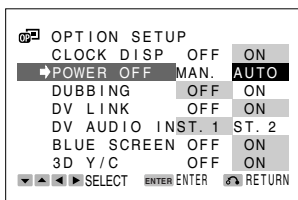

- **MAN.:** The recorder does not turn off until the **POWER** is pressed.
- **AUTO:** Turns off the power automatically when you do not operate the recorder for about 3 hours.

DUBBING

When recording material played back with this recorder using other equipment, the contents displayed on the TV screen may also be recorded. This function is for preventing this from happening.

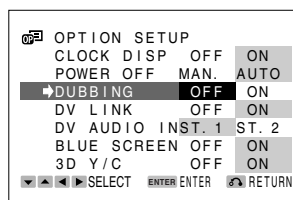

- **OFF:** On screen display displayed when playing back a disc is displayed to match switching of the on-screen display (page 28).
- **ON:** On screen display displayed when playing back a disc is canceled so that only the played back material is output.

* Some error messages are displayed.

DV LINK

When recording with this recorder by connecting a digital camcorder using the DV IN/OUT terminal, the digital camcorder can be controlled with the remote control of this recorder.

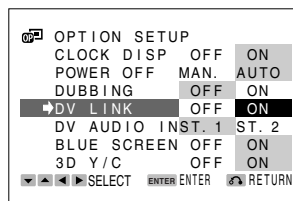

- * Refer to page 95 for information on the procedure when connecting this recorder with a digital camcorder.
 - **OFF:** Set to OFF when the digital camcorder does not operate properly when the recorder is connected to a digital camcorder and controlled with the remote control of this recorder.
 - **ON:** A digital camcorder connected to this recorder can be controlled with the remote control of this recorder.
- * Discs cannot be played back when it is set to "ON" and DV input has been selected.



Option Setup Screen

DV AUDIO IN

You can select the audio to be recorded when recording material from a digital camcorder using the DV IN/OUT terminal.

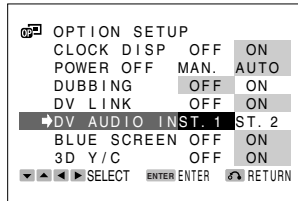

- **ST. 1:** Original audio
 - **ST. 2:** Overdubbed audio
 - Monaural audio cannot be input through the DV IN/OUT terminal.
- * The DV input audio settings are disabled when the audio output of the digital camcorder that is connected is set to 16 bits.

BLUE SCREEN

This function automatically switches material containing unwanted noise to a blue screen when a channel for which there is no broadcast or a channel for which broadcasting has ended has been selected.

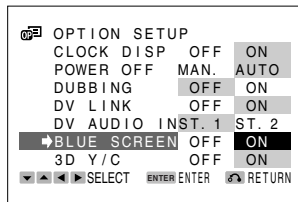

- **OFF:** The Blue Screen function does not work.
 - **ON:** The Blue Screen function works.
- * The display may switch to the blue screen when material has been input from external input that involves a special playback format. Set this function to "OFF" if this happens.

3D Y/C

The 3D Y/C separation circuit is a function that lets you enjoy clear viewing and recording of TV broadcasts or recorded material from equipment connected to the external input.

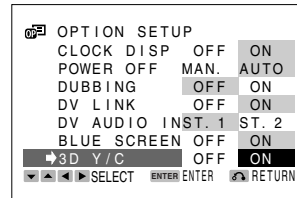

- **OFF:** Set this function to "OFF" when images appear incorrectly during reception of a weak broadcast signal, or when the picture is distorted when a video deck or video game machine is connected to the external input jack of this recorder.
 - **ON:** Enables recording with higher picture quality (Normally, this function is set to "ON").
- * This function is not activated for DV input or S-Video.

Option Setup Screen

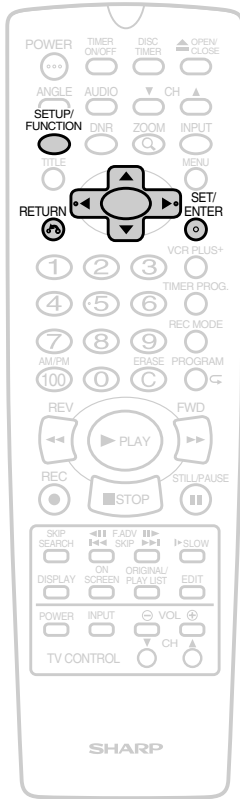

Basic Settings of the Option Setup Screen

DVD VIDEO | DVD RW | DVD RW | DVD R | VIDEO CD
 VR MODE | VIDEO MODE
 AUDIO CD

NOTE

- During playback, you cannot set each item in the SETUP screen. Press **STOP** to stop playback.

Example: Set "CLOCK DISP" to "ON"

1 Press **SETUP/FUNCTION** to display the **SETUP** screen.

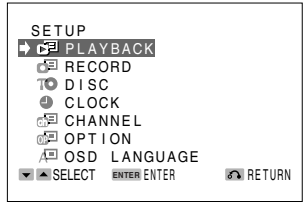

2 Press **▲ / ▼** to select "OPTION" and then press **SET/ENTER**.

- The OPTION SETUP screen appears.
- Press **RETURN** to return to the previous screen.

3 Press **▲ / ▼** to select "CLOCK DISP".

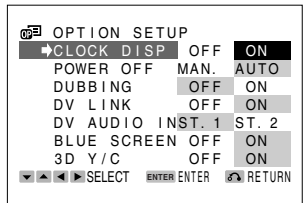

4 Press **◀ / ▶** to select "ON" and then press **SET/ENTER**.

- Each time **◀ / ▶** is pressed, the mode toggles between "ON" and "OFF".
- Press **SETUP/FUNCTION** to exit the SETUP screen.

Connecting to Audio Equipment

Playing 2 channel audio with an Analog Connector

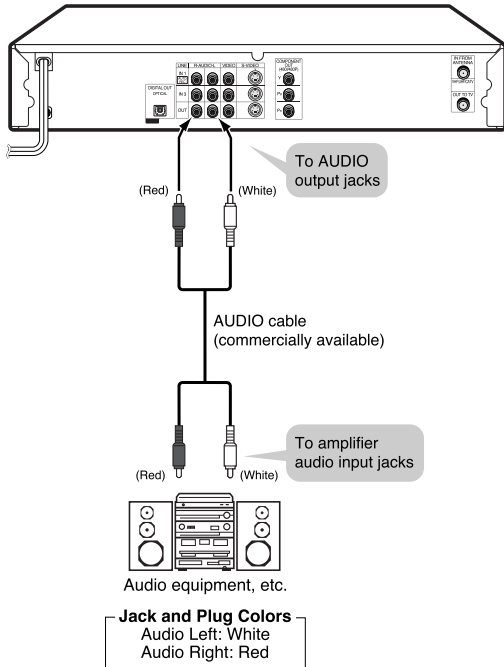

NOTE

- When connecting the audio equipment to the analog connection, we recommend that you set the "DD LEVEL" in "PLAYBACK SETUP" to "OFF" (See page 81).

Playing Dolby Digital (5.1 channel) and DTS audio with a Digital Connection

- Connecting an amplifier with a Dolby Digital/DTS digital surround processor or a Dolby Digital/DTS digital surround decoder to the recorder's optical digital jack provides richer, more powerful audio play.
- To use DTS digital surround, press **AUDIO** to select DTS audio.

■ Connection to a processor or amplifier with a optical digital input jack

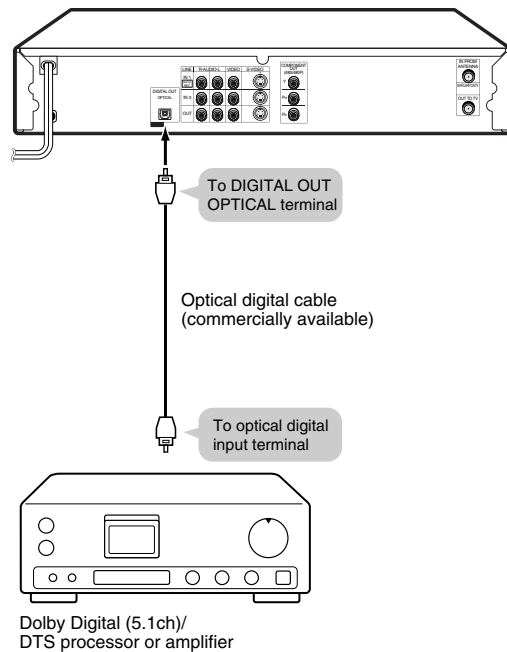

! Important!

- When using this connection, set the "Digital OUT" in "PLAYBACK SETUP" to "DIGITAL" (See page 81).

NOTE

- To play a disc recorded with DTS, you need to use DTS processor or amplifier.
- This connection is not possible if the processor or amplifier to which you want to connect does not have a optical digital input jack.
- Refer to the operation manual for the processor or amplifier for information about connecting to it.

Connecting to Audio Equipment

Playing 2 channel audio with a Digital Connection

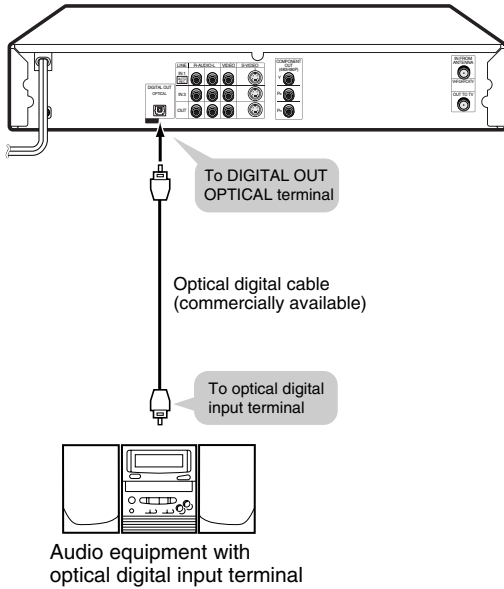

■ Digital Connection to Audio Equipment or MD Player without a Dolby Digital Decoder

- Audio CD or Video CD
You can enjoy these discs by playing them back the ordinary playback procedure. (The normal audio output is not played back for discs recorded with DTS.)
- DVD Video Disc
There is no audio signal generated for DVD video discs recorded with DTS. A processor or amplifier equipped with a DTS Surround decoder function is required to enjoy DTS audio.

! Important!

- When connecting the audio equipment to the digital connection, set the "Digital OUT" in "PLAYBACK SETUP" to "PCM" (See page 81).

NOTE

- No sound will come out from the DIGITAL OUT OPTICAL terminal.

Digital Connection to an MD to Record a CD

When you are using a digital connection to record the contents of a CD to an MD, the track numbers of the CD may not match the track numbers recorded to the MD.



Connecting to Audio Equipment

Recording by Connecting with a Digital Camcorder Using i.LINK

DVD RW VR MODE DVD RW VIDEO MODE DVD R

This function lets you make high picture quality and high sound quality recordings by connecting with a digital camcorder using the DV IN/OUT terminal (i.LINK). You can record material from this recorder with a digital camcorder, or record material from a digital camcorder with this recorder.

In addition, you can also record while controlling the digital camcorder with the remote control of this recorder (DV uptake).

* i.LINK is a function that lets you control other equipment by input and output of video, audio, data and control signals between equipment having an i.LINK jack.

* i.Link refers to the IEEE1394-1995 industry specification and extensions thereof. The  logo is used for products compliant with the i.Link standard.

DV IN/OUT Terminal

About the Connected Equipment

When this recorder is connected with a DV-format camcorder using a DV cable, you can record and edit with minimal deterioration of picture and sound quality using a digital signal.

NOTE

- The DV IN/OUT terminal of this recorder only enables input and output of DV-format camcorders (DVC-SD signals). It is not compatible with satellite receivers or Digital VHS video recorders since they employ a different format.
- When this recorder is connected with a camcorder equipped with a DV terminal, the signal may not be input to this recorder depending on the camcorder. When this happens, use an analog connection (page 98).
- The DV IN/OUT terminal is not compatible with connection to a PC.
- This recorder cannot be controlled from other equipment by using the DV IN/OUT terminal.
- Only one camcorder can be connected to this recorder using the DV IN/OUT terminal.
- Connect this recorder and the camcorder directly. The DV signal will not be input if the camcorder is connected to this recorder through other equipment equipped with a DV IN/OUT terminal.
- When two of these recorders are connected using the DV IN/OUT jack, one cannot be used to control the other.
- Signals may not be able to be output or control may not be possible from this recorder in the case of some digital camcorders (page 96).

Input/Output of Video, Audio and Data Signals

- Date and time data as well as the contents of cassette memory cannot be recorded with this recorder.
- Video and audio signals from TV programs, external inputs, CDs or Video CDs cannot be output.
- Video and audio signals of protected material or "copy-once" material cannot be output.
- Video and audio signals of protected material or "copy-once" material cannot be recorded.
- Monaural audio cannot be input through the DV IN/OUT terminal.

Audio Mode

Digital camcorders typically have the following two audio modes.

16-bit (48 kHz)

Although this yields high sound quality, only one stereo audio signal can be processed.

12-bit (32 kHz)

Two stereo signals can be processed. In general, overdubbed audio is recorded in Stereo 2.

- This recorder allows listening or recording of either Stereo 1 or Stereo 2 audio if the input audio is in the 12-bit audio mode.
- Only the 16-bit audio mode is output from this recorder.
- This recorder is unable to process 44.1 kHz input audio signals.

Connecting Using the DV IN/OUT Terminal (i.LINK)

Refer to the user's manual provided with the camcorder for information on the procedure for connecting the camcorder with this recorder.

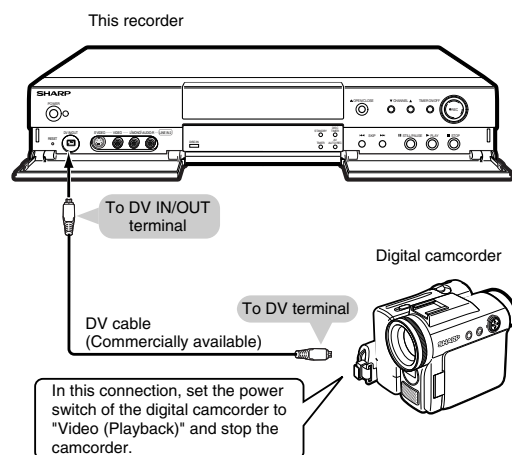

Connecting to Audio Equipment

Recording with this recorder (DV Uptake)

You can record images from a digital camcorder connected to the DV IN/OUT terminal of this recorder. You can also control the operation of the camcorder with the remote control provided with this recorder, making it easy to record material from a camcorder onto a disc.

Record material from a camcorder after first setting the "DV AUDIO IN" (page 91) of "OPTION SETUP".

NOTE

- Material protected with a copy guard cannot be recorded.
- Date and time data as well as the contents of cassette memory cannot be recorded.
- Discs cannot be played back when "DV LINK" is set to "ON" during DV input. Set the "DV LINK" to "OFF" when you want to play back recorded material.
- The video and audio signals of Audio CDs or Video CDs are not output.
- The video and audio signals of protected material or copy-once material are not output.

1 Setup

① Connect the digital camcorder to the DV IN/OUT terminal.

- Set the power switch of the camcorder to "Video (Playback)" and connect while it is stopped.

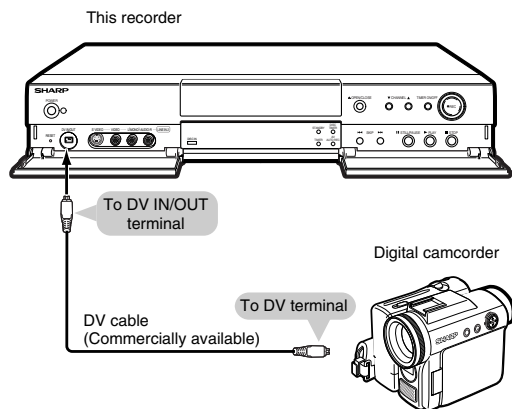

② Place a disc for recording in the recorder.

2 Select the external input audio.

- Before starting recording, check the setting of "DV AUDIO IN" (page 91).
- Monaural audio cannot be input through the DV IN/OUT terminal.

3 Press INPUT.

- The setting changes in the order of DV (DV Input), L 1 (External Input 1), L 2 (External Input 2), L 3 (External Input 3), Channel and then back to DV (DV Input) each time this is pressed.
- When "DV LINK" is set to "ON", the digital camcorder can be controlled with the remote control of this recorder.
- The following buttons can be used:
▶PLAY, FWD▶▶, ◀◀REV, ■STOP, SLOW and ■■STILL/PAUSE.

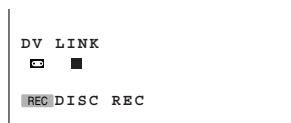

4 Begin playback of the digital camcorder.

5 Press ●REC where you want to start recording.

- This recorder begins to record.
- Recording by this recorder pauses if there is a portion of the digital camcorder playback where nothing has been recorded or playback is stopped during recording. When a recorded portion of the playback is again played back, pause is canceled and recording resumes.

6 Pause recording (as necessary).

When "DV LINK" is "ON": Press ●REC.

When "DV LINK" is "OFF": Press ■■STILL/PAUSE.

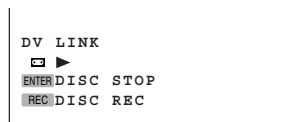

7 Stop (end) recording.

When "DV LINK" is "ON": Press SET/ENTER.

When "DV LINK" is "OFF": Press ■STOP.

Refer to the section on "Troubleshooting" (page 100) when DV uptake does not function properly.

! Important!

Abnormal images may be recorded when any of the following occur during DV uptake.

- When connected equipment plays back a portion where nothing is recorded
- When the DV cable is disconnected or the camcorder power is turned off during DV uptake
- When playback from the camcorder is stopped



Connecting to Audio Equipment

NOTE

- Only DVC-SD signals can be input from the DV IN/OUT terminal of this recorder.
- There are some digital camcorders that cannot be operated with the remote control of this recorder even if "DV LINK" is set to "ON". Set "DV LINK" to "OFF" when this happens (page 90).
- When connecting a digital camcorder to this recorder, set the power switch of the digital camcorder to "Playback (Video)" and press **■STOP**. If the camcorder is connected with the power switch set to "RECORD (Camera)" or while it is playing back, DV Link will not function properly.
- This recorder cannot be controlled from the outside using the DV IN/OUT terminal.
- When two of these recorders are connected using the DV IN/OUT jack, one cannot be used to control the other.
- Date and time data as well as the contents of cassette memory cannot be recorded.
- **Discs cannot be played back while "DV LINK" is set to "ON" during DV input. If you want to play back a disc, set "DV LINK" to "OFF" after recording is finished.**

NOTE

- Images protected with a copy guard are not output to the DV IN/OUT terminal.
- Video and audio signals of protected material or "copy-once" material cannot be output.
- When disc information (page 28) is displayed, that information is also displayed on images output from the digital camcorder. Turn off the display of disc information when recording images output from the DV IN/OUT terminal with a digital camcorder.
- The DV IN/OUT terminal of this recorder functions as a connection terminal for digital camcorders. Images may not be able to be taken up or output properly if other equipment (such as PC) is connected to this terminal.
- Since recording is performed in 30 seconds units (1 minute units in the LP mode) when recording in the Video mode, recording may continue briefly after it is finished.
- The DV output cannot be used during progressive playback (page 80).
- This recorder is only able to output 16-bit audio.

Recording with a Digital Camcorder

When playback is started with this recorder after the channel has been set to a channel other than DV, the DV IN/OUT terminal functions as an external input jack. (When DV input has been selected, there is no signal output from the DV IN/OUT terminal.)

1 Connect the digital camcorder to the DV IN/OUT terminal on this recorder.

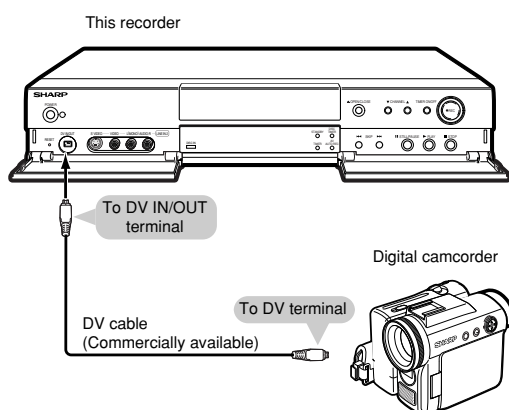

2 Play back the recorded material with this recorder.

- The material played back with this recorder is output to the digital camcorder.

Important!

Proper images may not be recorded when any of the following occur during DV uptake.

- When the digital camcorder plays back a portion where nothing is recorded
- When the DV cable is disconnected or the camcorder power is turned off during recording
- When playback from the camcorder is stopped



Connecting to Audio Equipment

Recording Using an Analog Connection with a Digital Camcorder

DVD RW VR MODE DVD RW VIDEO MODE DVD R

Material from a digital camcorder can be recorded with this recorder using an analog connection between this recorder and the digital camcorder.

NOTE

- It is recommended to use the DV IN/OUT terminal when connecting a digital camcorder equipped with a DV terminal. (Refer to the section on "Recording by Connecting with a Digital Camcorder Using i.LINK" (page 95).)
- More vivid images can be viewed by connecting the S-VIDEO IN jack on this recorder with the S-VIDEO OUT jack on the camcorder using an S-VIDEO cable.
- Some camcorders may be required to be connected using a special cable.
- Refer to the operation manual provided with the camcorder for further information on the procedure for connecting the camcorder.

2 Select the external input audio.

- Refer to the section on "EX. AUDIO" (page 86) or the section on "D-MONO REC" (page 86).

3 Press INPUT to set to the channel of the external input.

- The setting changes in the order of DV (DV Input), L 1 (External Input 1), L 2 (External Input 2), L 3 (External Input 3), Channel and then back to DV (DV Input) each time this is pressed.

4 Perform the procedure for recording with this recorder.

Recording with this Recorder

1 Setup

- 1 Connect the equipment to IN 2 of this recorder.

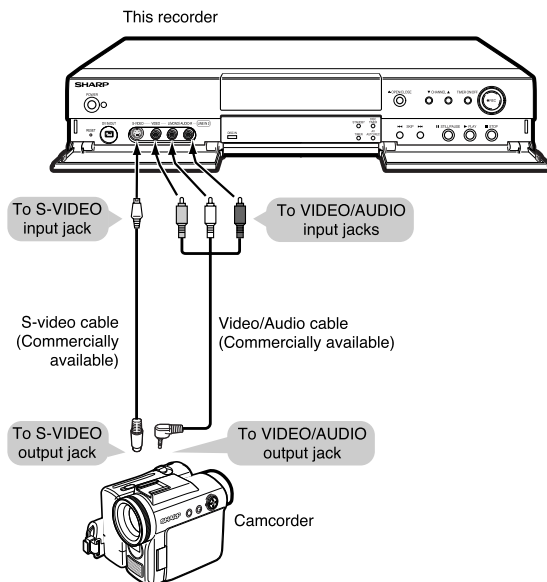

- 2 Load a disc for recording in the recorder.



Recording Material from External Equipment

DVD RW VR MODE DVD RW VIDEO MODE DVD R

You can record material from equipment connected to one of the external input jacks of this recorder (IN 1, IN 2 or IN 3).

1 Setup

- 1 Connect the equipment to an external input jack of this recorder.

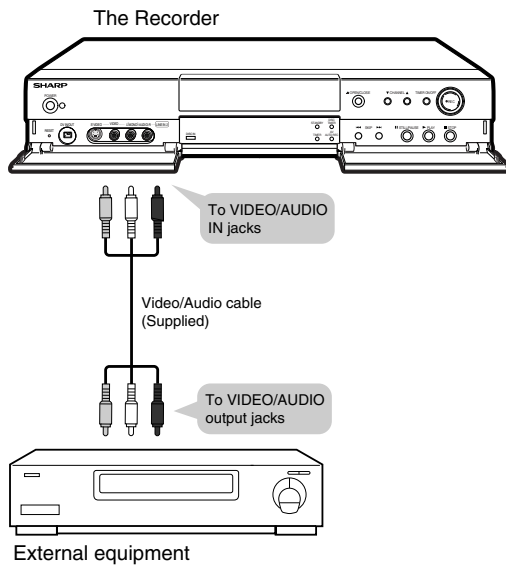

- 2 Place a disc for recording in this recorder.

2 Select the external input audio.

- Refer to the section on "EX. AUDIO" (page 86) or the section on "D-MONO REC" (page 86).

3 Press INPUT.

- The setting changes in the order of DV (DV Input), L 1 (External Input 1), L 2 (External Input 2), L 3 (External Input 3), Channel and then back to DV (DV Input) each time this is pressed.

4 Perform the procedure for recording with this recorder.

NOTE

- Material protected with a copy guard cannot be recorded. In addition, proper images may not be able to be viewed even when only viewing such material without recording.

Troubleshooting

The following problems do not always denote a broken this recorder.
Perform the checks listed below before calling service.

Problem	Suggested Solution
The recorder does not switch on	<ul style="list-style-type: none">• Is the power cord firmly plugged into the power outlet?
The disc is automatically ejected after closing the disc tray	<ul style="list-style-type: none">• Make sure that the disc is loaded properly (aligned in disc tray and label-side up)• Take out the disc and clean it• Make sure that region number on the disc match the region number in this recorder• Make sure that the disc is playable
No picture	<ul style="list-style-type: none">• Make sure that the cables are connected correctly• Make sure that the connected TV and the AV receiver is set to the correct input• Take out the disc and clean it• Make sure that region number on the disc match the region number in this recorder
The recorder does not play a disc	<ul style="list-style-type: none">• Take out the disc and clean it• Make sure that the disc is loaded properly (aligned in disc tray and label-side up)• Make sure that region number on the disc match the region number in this recorder• Remove the dew in the recorder• Check that the disc is NTSC• Make sure that "DV LINK" in "OPTION SETUP" to "OFF" when selecting DV input
Settings have disappeared	<ul style="list-style-type: none">• If the recorder is unplugged (or there is a power failure) for more than about 1 hour while the recorder is on, all the settings will be lost. Make sure that you turn off the recorder before unplugging the power cord
Screen goes blank and operation buttons do not work	<ul style="list-style-type: none">• Press ■STOP and restart playback• Turn off the power and turn on the power again
No sound and/or picture from a camcorder connected to the DV IN/OUT terminal	<ul style="list-style-type: none">• Since played back material is not output when DV input has been selected, select another channel when you want to playback recorded material.• Make sure that "PROGRESSIVE" in "PLAYBACK SETUP" to "OFF"
The remote control does not work	<ul style="list-style-type: none">• Check that the Tamper Proof function is active• Set the remote control to the same ID number as the recorder• Use the remote control within its operating range• Replace the batteries
No sound or sound is distorted	<ul style="list-style-type: none">• Make sure that the volume of the amplifier/receiver or TV is not set to minimum• There is no sound during still mode, slow motion playback, fast forward and fast rewind• DVD audio recorded in DTS is only output from the DIGITAL OUT OPTICAL terminal. Connect a DTS-compatible digital amplifier or decoder to this recorder.• Check that the audio cable is connected correctly• Check that the cable plugs are clean• Take out the disc and clean it• Audio may not be able to be output depending on the audio recording status, such as when audio other than an audio signal or non-standard audio is recorded for the audio content recorded on a disc.
The picture from the external input is distorted	<ul style="list-style-type: none">• If the signal is copy-protected, you cannot connect via this recorder. Connect the component directly to your TV
The screen is stretched vertically or horizontally	<ul style="list-style-type: none">• This recorder's input switches into wide mode automatically according to the input signal. When the unit connected is not compatible with ID-1, the screen does not wide mode• Check that the aspect ratio settings of your TV
A disc recorded using this recorder cannot be played back on another player	<ul style="list-style-type: none">• Check that the disc is finalized• Some player will not play even a finalized disc• If the disc was recorded in VR mode, the other player must be RW compatible in order to play the disc
The recorder does not record	<ul style="list-style-type: none">• Check that the blank space on the disc remains• Check that the disc is protected• Check that the number of titles on the disc has already reached 99• Check that the source you are trying to record is not copy protected• Check that there wasn't a power failure during the timer recording• Check that the 2 timer programs may have overlapped



Troubleshooting

Problem	Suggested Solution
Can not control your TV using this remote control	<ul style="list-style-type: none"> Check that you entered the correct code for your TV
Unable to Record, Timer Record or Automatically Record from an External Input	<ul style="list-style-type: none"> Place a disc for recording (DVD-R or DVD-RW) in the recorder and after confirming that disc identification (loading) has been completed, perform the respective procedures for recording, timer recording or automatically recording from an external input.
Nothing is Recorded Following Recording	<ul style="list-style-type: none"> There is nothing recorded when a channel has been recorded that is not broadcasting (or for which broadcasting has ended). There may also be nothing recorded when a channel with poor reception has been recorded.
Unable to Record onto a DVD-RW Disc in the Video Mode	<ul style="list-style-type: none"> Use a Ver 1.1 disc or later. (The version is usually indicated on the back of the disc jacket).
Images from a Camcorder Connected to the DV IN/OUT terminal are not Displayed, are Displayed without Sound or the Camera does not Operate Properly	<ul style="list-style-type: none"> Recorded material protected with a copy guard cannot be viewed. Check the connections. Turn the power OFF and then turn it back ON again. Reconnect the DV cable. Try setting "DV LINK" to "OFF". Switch "DV AUDIO IN".
A Camcorder Connected to the DV IN/OUT terminal cannot be Controlled with this Product	<ul style="list-style-type: none"> Set "DV LINK" to "ON". Some types of camcorders may not be able to be controlled.
Images are Distorted (Appear Improperly) during External Input or Broadcasts with Poor Reception	<ul style="list-style-type: none"> Switch "3D Y/C" to "OFF".
There is no On-screen Display during Playback	<ul style="list-style-type: none"> Check whether or not "DUBBING" is set to "ON". When this is set to ON, the on-screen display is forcibly set to OFF during playback.

NOTE

- This recorder is equipped with a microprocessor. Its performance could be adversely affected by external electrical noise or interference. If this should happen, unplug the product and plug it in again after a few minutes.
- Press **RESET** with a toothpick or other narrow rod-like object (nonmetal) when the recorder does not operate properly even after the power has been turned off and then back on again.
- Since the clock, channel, timer recording programs and other data in memory are also reset when **RESET** has been pressed, they must be set again.
- EZ Set Up function starts automatically when **RESET** is pressed.

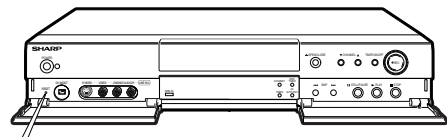

Service Informatino (For the U.S.)

For the location of the nearest Sharp Authorized Service Center, or to obtain product literature, accessories, supplies or customer assistance, please call **1-800-BE-SHARP** (1-800-237-4277) or visit SHARP's website (<http://www.sharp-usa.com>).

- Do not attempt to service this product yourself. Instead, unplug it and contact a qualified service technician. (See **CONSUMER LIMITED WARRANTY** at the end of this manual.)
- Be sure the service technician uses authorized replacement parts or their equivalents. Unauthorized parts may cause fire, electrical shock, or other hazards.
- Following any service or repair, be sure the service technician performs safety checks to certify that this product is in safe operating order.



Glossary

- Angle** Recorded onto some DVD discs are scenes which have been simultaneously shot from a number of different angles (the same scene is shot from the front, from the left side, from the right side, etc.). With such discs, you can select the angle on Function Control Screen to view the scene from different angles.
- Chapter Number** These numbers are recorded on DVD discs. A title is subdivided into many sections, each of which is numbered, and specific parts of video presentations can be searched quickly using these numbers.
- Digital Gamma** Corrects for gradations in dark areas of images to make images clearer.
- Digital Super Picture** Enhances the fine detail of the image and outlines of the objects it contains.
- DiscNavi** DiscNavi displays a list of the first scene of each titles when playing a DVD-R/DVD-RW disc recorded in this recorder.
- Dolby Digital (5.1 channel)** A sound system developed by Dolby Laboratories Inc. that gives movie theater ambience to audio output when the product is connected to a Dolby Digital 5.1 channel processor or amplifier.
- Dolby Digital output level** Setting that increases the average volume of Dolby Digital audio when playing a DVD.
- DTS** This is a digital sound system developed by Digital Theater Systems for use in cinemas. This system uses 6 audio channels and provides accurate sound field positioning and realistic acoustics. (By connecting a DTS Digital Surround decoder, you can also listen to DTS Digital Surround sound.)
- Exact Rec** This function automatically changes the recording mode to prevent recordings from running out before they are finished due to a lack of available disc space by comparing the available disc space and the time required for the timer recording.
- EZ Set Up** Tuner channels and clock are automatically set for both Air and Cable channels.
- Finalization** Finalization is required to play DVD discs with another DVD player or DVD video-compatible PC.
- Initialization** Initialization is required when using DVD-RW discs in the Video mode.
- Letter Box**  Screen size that cuts off the top and bottom of the image to allow playing of Wide (16:9) software on a connected 4:3 TV.
- Linear PCM Sound** Linear PCM is a signal recording format used for Audio CDs. The sound on Audio CDs is recorded at 44.1 kHz with 16 bits. (On DVD discs, sound is recorded at between 48 kHz with 16 bits and 96 kHz with 24 bits.)
- MP3** One type of audio compression that uses MPEG1. This format compresses sound to about 1/10, without impairing the original sound quality.
- Original (ORG)** An image of title created when they are recorded the disc is called "Original".



Glossary

Pan Scan

4:3 | PS

Screen size that cuts off the sides of the image to allow playing of Wide (16:9) software on a connected 4:3 TV.

Playlist (PL)

Titles for editing created based on an original are called "Playlist".

Playback Control (PBC)

This is recorded on a video CD (version 2.0). The scenes or information to be viewed (or listened to) can be selected into actively with the TV monitor by looking at the menu shown on the TV monitor.

Region Number

Number identifying a geographic region of compatibility for a DVD.

Subtitles

These are the printed lines appearing at the bottom of the screen which translate or transcribe the dialog. They are recorded on DVD discs.

Time Number

This indicates the play time which has elapsed from the start of a disc or a title. It can be used to find a specific scene quickly. (It may not work with some discs.)

Title Menu

This is a menu displayed by some DVDs for selection of chapters and subtitle set. The title menu is also called a "top menu".

Title Number

These numbers are recorded on DVD discs. When a disc contains two or more movies, these movies are numbered as title 1, title 2, etc.

Track Number

These numbers are assigned to the tracks which are recorded on video CDs and Audio CDs. They enable specific tracks to be located quickly.

VBR

VBR is the abbreviation for Variable Bit Rate control. This feature performs control by varying the bit rate (the amount of code transferred in a fixed period of time) by assigning a larger amount of code to complex video images such as sections containing rapid movement or sections containing sudden changes in color, and assigning a smaller amount of code in the opposite cases.

Video Mode

This recording format is compatible with commercially available DVD players and DVD-ROM drive.

VR Mode

This recording format is the basic DVD-RW recording format, and lets you enjoy the various editing functions available with this recorder.

Specifications

General

Power supply: AC 120 V, 60 Hz
Power consumption
(Normal): 40 W
Power consumption
(Standby): 0.9 W (During the Front Panel
Display is off.)
Dimensions: Approx. 430 mm x 82 mm x 361 mm
(W x H x D)
Approx. 16^{15/16}" x 3^{1/4}" x 14^{1/4}"
Weight: Approx. 5.1 kg (11.3 lbs)
Operating temperature 5°C to 35°C (41°F to 95°F)
Storage temperature: -20°C to 55°C (-4°F to 131°F)
Operating humidity: 5% to 80%(no condensation)
Discs Played: DVD Video, DVD-R/RW, Audio
CD (CD-DA), Video CD
CD-R/RW (CD-DA, MP-3 file
format)
TV systems: NTSC system, 525 lines, 60
fields

Recording

Recording format: DVD-Video Recording
(VR mode)
DVD-VIDEO (Video mode)
Recording discs: DVD-RW
DVD-R
Video recording format:
Sampling frequency: 13.5 MHz
Compression format: MPEG
Audio recording format:
Sampling frequency: 48 kHz
Compression format: Dolby Digital
Recording time (Using the 4.7 GB disc):
DVD-RW (VR mode): FINE: Approx. 60 minutes
SP: Approx. 120 minutes
LP: Approx. 240 minutes
EP: Approx. 360 minutes
DVD-R/RW (Video mode): FINE: Approx. 60 minutes
SP: Approx. 120 minutes
LP: Approx. 240 minutes

Tuner

Channel coverage: VHF 2-13
UHF 14-69
CATV 1-125

Timer

Programs: 1 year/8 programs
Clock: Quartz lock
(12-hour digital display)
Memory backup: Approx. 1 hour

Input/Output

VHF/UHF antenna input/
output terminal: 75Ω (F-shape Connector)
Video input: Input 1, 3(rear), 2 (front)
Input level: 1 Vp-p (75Ω)
Jacks: RCA jack
Video output:
Output level: 1 Vp-p (75Ω)
Jacks: RCA jack
S-Video input: Input 1, 3(rear), 2 (front)
Y-Input level: 1 Vp-p (75Ω)
C-Input level: 0.286 Vp-p (75Ω)
Jacks: 4 pin mini DIN
S-Video output:
Y-Output level: 1 Vp-p (75Ω)
C-Output level: 0.286 Vp-p (75Ω)
Jacks: 4 pin mini DIN
Component video output:
Output level: Y: 1 Vp-p (75Ω)
Pb, Pr: 0.7 Vp-p (75Ω)
Jacks: RCA jack
Audio input: Input 1, 3 (rear), 2 (front) L/R
Input level: 2 V rms (Input impedance: more
than 22 kΩ)
Jacks: RCA jack
Audio output: L/R
Input level: 2 V rms (Output impedance:
less than 1.5 kΩ)
Jack: RCA jack
Digital audio optical output:
Terminal: Square Optical terminal
DV input/output:
Terminal: 4 pin (i.LINK/IEEE 1394
standard)

LASER Specification

Wave length: DVD: 650 nm
CD: 780 nm
Laser power: DVD: 70 mW
CD: 108 mW

Specifications are subject to change without notice.



ESPAÑOL

(Guía de operación rápida)

MEDIDAS DE SEGURIDAD IMPORTANTES	107
Guía de operación rápida en español	108
Conexión básica	108
EZ Set Up	108
Reproducción de DVD	109
Reproduce solamente los discos para reproducción	109
Avance rápido/Retroceso rápido	109
Función de avance rápido/retroceso rápido (búsqueda) sobre la grabadora	109
Omisión (Avance/Retroceso)	110
Cámara lenta	110
Avance de cuadro, Imagen fija/pausa	110
Grabación básica	111



Para futura referencia, anote los números de modelo y de serie (indicados en la parte posterior este producto) en el espacio provisto.

Nº. de modelo: DV-RW2U

Nº. de serie: _____

AVISO: PARA REDUCIR EL RIESGO DE INCENDIO O ELECTROCHOQUE NO EXPONGA ESTE APARATO A LA HUMEDAD.

	<p>PRECAUCION PELIGRO DE DESCARGA ELECTRICA NO ABRIR</p>		 <p>Este símbolo previene al usuario del voltaje aislado dentro de la unidad que puede provocar descargas eléctricas peligrosas.</p>
<p>PRECAUCION: TPARA REDUCIR EL RIESGO DE DESCARGA ELECTRICA, NO quite la cubierta. EL USUARIO NO DEBERA DAR NINGUN TIPO DE SERVICIO A NINGUNA PARTE INTERNA. DEBERA SER REALIZADO SOLO POR PERSONAL DE SERVICIO CALIFICADO.</p>			 <p>Este símbolo advierte al usuario que existen instrucciones de operación y de mantenimiento en la literatura incluida en esta unidad.</p>

“ADVERTENCIA—Las reglas de la FCC (Comisión Federal de Comunicaciones) estipulan que cualquier modificación o cambio a este equipo no aprobado expresamente por el fabricante podrá anular la autorización del usuario para operar este equipo”.

INFORMACION

Este equipo se ha sometido a todo tipo de pruebas y cumple con las normas establecidas para dispositivo digital de Clase B, de conformidad con la Parte 15 de las reglas de la FCC (Comisión Federal de Comunicaciones). Estas reglas están diseñadas para asegurar una protección razonable contra interferencias perjudiciales en las instalaciones residenciales. Este equipo genera, utiliza y puede emitir energía de radiofrecuencia y, si no se instala y utiliza debidamente, es decir, conforme a las instrucciones, podrían producirse interferencias perjudiciales en las radiocomunicaciones. Sin embargo, no se garantiza que estas interferencias no se produzcan en una instalación determinada. Si este equipo ocasiona interferencias en la recepción de radio o televisión, lo cual puede comprobarse con sólo apagar y encender el equipo, intente corregir el problema mediante una o una combinación de las siguientes medidas:

- Reoriente la antena receptora o cámbiela de lugar.
- Aumente la separación entre el equipo y el receptor.
- Enchufe el equipo a una toma de corriente situada en un circuito distinto del receptor.
- Consulte a su distribuidor o a un técnico experto en radio/televisión.

PRECAUCION:

ESTA UNIDAD HA SIDO CLASIFICADA COMO PRODUCTO CLASS 1 LASER.

EL USO DE MANDOS O AJUSTES O LA REALIZACION DE PROCEDIMIENTOS DISTINTOS DE LOS INDICADOS EN LA PRESENTE IMPLICA EL RIESGO DE EXPOSICION A UNA RADIACION PELIGROSA.

COMO LOS RAYOS LASER UTILIZADOS EN ESTA UNIDAD PUEDEN RESULTAR PERJUDICIALES PARA SUS OJOS, NO INTENTE DESARMAR EL GABINETE. SOLICITE EL SERVICIO UNICAMENTE A PERSONAL CUALIFICADO.

Aviso al instalador de sistemas CATV:

Este aviso tiene la finalidad de llamar la atención del instalador de sistemas CATV para que tenga en cuenta el Artículo 820-40 de NEC, que ofrece instrucciones para realizar una conexión a tierra apropiada y, en particular, especifica que el cable de puesta a tierra deberá conectarse al sistema de puesta a tierra del edificio tan cerca del punto de entrada del cable como sea posible.

Como socio de ENERGY STAR®, SHARP ha determinado que este producto cumple con las pautas de ENERGY STAR® para uso eficiente de energía. ENERGY STAR es una marca registrada estadounidense.



MEDIDAS DE SEGURIDAD IMPORTANTES

PRECAUCIÓN: Lea todas estas instrucciones antes de utilizar este producto y guárdelas para consultarlas posteriormente.

La energía eléctrica permite realizar muchas funciones útiles. Este producto se ha diseñado y fabricado para garantizar su seguridad personal. EL USO INADECUADO PUEDE RESULTAR EN PELIGROS DE DESCARGAS ELÉCTRICAS O INCENDIOS POTENCIALES. Con el fin de respetar las medidas de seguridad incorporadas en este producto, tenga en cuenta las siguientes reglas básicas de instalación, uso y servicio técnico.

- 1. Lectura de las instrucciones** – Todas las instrucciones de seguridad y uso deben leerse antes de utilizar el producto.
- 2. Conservación de las instrucciones** – Las instrucciones de seguridad y uso deben guardarse para usarlas como referencia en el futuro.
- 3. Advertencias** – Deben observarse todas las advertencias del producto y de las instrucciones de uso.
- 4. Instrucciones** – Deben seguirse todas las instrucciones de uso.
- 5. Limpieza** – Desenchufe este producto de la toma de alimentación antes de limpiarlo. No utilice limpiadores líquidos ni aerosoles. Utilice un paño húmedo.
- 6. Aditamentos** – No utilice aditamentos no recomendados por el fabricante del producto, ya que pueden causar peligros.
- 7. Agua y humedad** – No utilice este producto cerca del agua, por ejemplo, cerca de una bañera, cubeta de lavado, fregadero de cocina, en un sótano húmedo, ni cerca de una piscina, etc.
- 8. Accesorios** – No coloque este producto sobre un carrito, soporte, trípode o mesa inestable. El producto podría caerse, causando heridas graves a niños o adultos y daños graves al propio producto. Utilícelo solamente con un carrito, soporte, trípode o mesa recomendado por el fabricante o vendido con el producto. Cualquier trabajo de montaje del producto deberá realizarse según las instrucciones del fabricante, y deberán utilizarse los accesorios de montaje recomendados por él.
- 9. Transporte** – Mueva el producto con cuidado cuando se encuentre en un carrito. Las paradas bruscas, la fuerza excesiva o las superficies desniveladas pueden causar que el producto y el carrito se caigan.



- 10. Ventilación** – Las ranuras y aberturas de la caja se proporcionan para la ventilación del producto, para asegurar un funcionamiento fiable y para protegerlo contra el sobrecalentamiento, y a la misma vez, estas aberturas no deben bloquearse ni cubrirse. Con el fin de que las aberturas no queden bloqueadas, no coloque el producto sobre una cama, sofá, alfombra u otras superficies similares. Este producto no debe instalarse en un espacio cerrado, como un estante para libros, a menos que reciba una ventilación adecuada o que las instrucciones del fabricante hayan sido observadas.
- 11. Fuentes de alimentación** – Este producto debe utilizarse únicamente con el tipo de fuente de alimentación especificada en la etiqueta de características. Si no está seguro del tipo de suministro eléctrico existente en su hogar, consulte con el proveedor de producto o con la compañía eléctrica local. Con respecto al producto diseñado para utilizarse con pilas, o otras fuentes de suministro consulte el manual de instrucciones.
- 12. Puesta a tierra o polarización** – Este producto dispone de un enchufe polarizado de dos cables (una cuchilla del enchufe es más grande que la otra) o con un enchufe puesto a tierra de tres cables (un tercer conector para puesta a tierra). El enchufe polarizado de dos cables encaja en la toma de alimentación en una única posición solamente. El enchufe a tierra de tres cables se conecta solamente en un tomacorriente con descarga a tierra. Si el enchufe no encaja, solicite a un electricista la sustitución de la toma de alimentación obsoleta. No modifique el enchufe y respete esta medida de seguridad.
- 13. Protección del cable de la alimentación** – Los cables de la alimentación deben instalarse de forma que nadie pueda caminar sobre ellos ni queden atrapados por artículos colocados sobre o contra ellos, poniendo mucha atención a las partes donde los cables entran en contacto con las clavijas, a las tomas de corriente y a los puntos por donde salen del producto.

- 14. Puesta a tierra de la antena exterior** – Si una antena exterior o sistema de cables está conectado al producto, asegúrese de que la antena o sistema de cables esté puesto a tierra de forma que proporcione cierta protección contra sobretensiones y acumulaciones de cargas estáticas. El estatuto 810 del Código Eléctrico Nacional ANSI/NFPA 70 proporciona información relativa a la puesta a tierra adecuada del poste y de la estructura de soporte, puesta a tierra del cable de entrada a una unidad de descarga de antena, tamaño de los conductores de puesta a tierra, ubicación de la unidad de descarga de antena, conexión a los electrodos de puesta a tierra y los requisitos correspondientes al electrodo de puesta a tierra. Refiérase al diagrama siguiente.

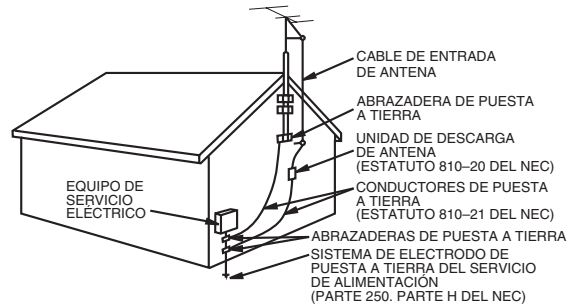

NEC- NATIONAL ELECTRICAL CODE (CÓDIGO ELÉCTRICO NACIONAL)

- 15. Relámpagos** – Como protección complementaria para este producto durante tormentas eléctricas o cuando no lo utilice durante mucho tiempo, desenchúfelo de la toma mural y desconecte la antena o sistema de cables. De esta forma se evitará que el producto se dañe debido a relámpagos y sobretensiones.
- 16. Líneas eléctricas** – Los sistemas de antenas exteriores no deben encontrarse cerca de líneas eléctricas aéreas o de otros circuitos de alimentación o de luz eléctrica, ni donde puedan caer sobre dichos circuitos o líneas. Cuando se instale un sistema de antena exterior, debe tenerse especial cuidado para evitar entrar en contacto con tales circuitos o líneas eléctricas, ya que tal contacto puede ser mortal.
- 17. Sobrecarga** – No sobrecargue las tomas murales, los cables prolongadores ni los receptores integrales, ya que si lo hace pueden producirse incendios o descargas eléctricas.
- 18. Introducción de objetos sólidos y líquidos** – No introduzca nunca ningún tipo de objeto en este producto a través de las ranuras de la caja, ya que pueden entrar en contacto con puntos de tensión peligrosos o cortocircuitar componentes, lo que podría provocar incendios o descargas eléctricas. No derrame nunca ningún tipo de líquido sobre el producto.
- 19. Servicio** – No intente reparar por sí mismo este producto, ya que al abrir o extraer las cubiertas puede quedar expuesto a tensión peligrosa y demás peligros. Solicite asistencia técnica a personal especializado.
- 20. Averías que necesitan ser reparadas** – Desenchufe este producto de la toma mural y solicite asistencia técnica a personal especializado en las siguientes condiciones:
 - a. Cuando el cable de alimentación o el enchufe esté dañado.
 - b. Si se ha derramado líquido sobre o caído objetos dentro del producto.
 - c. Si el producto ha estado expuesto a la lluvia o al agua.
 - d. Si el producto no funciona con normalidad al seguir las instrucciones del manual. Ajuste solamente los controles especificados en el manual de instrucciones, ya que el ajuste inadecuado de otros controles puede provocar daños que a menudo requieren un trabajo extenso por parte de un técnico especializado para que el producto recupere su funcionamiento normal.
 - e. Si el producto se ha caído o se ha dañado de alguna manera.
 - f. Cuando el producto exhiba un cambio evidente en su rendimiento (esto indica la necesidad de asistencia técnica).
- 21. Piezas de recambio** – Cuando sean necesarias piezas de sustitución, asegúrese de que el personal de servicio técnico ha utilizado las especificadas por el fabricante o que cuenten con las mismas características que las originales. Las sustituciones no autorizadas pueden provocar incendios, descargas eléctricas u otros peligros.
- 22. Comprobación de seguridad** – Después de haber finalizado cualquier servicio técnico o de reparación de este producto, solicite al técnico que realice comprobaciones de seguridad para determinar que el producto se encuentra en condiciones de funcionamiento.
- 23. Calor** – Este aparato deberá situarse alejado de fuentes de calor como, por ejemplo, radiadores, salidas de calor, estufas y otros aparatos que produzcan calor (incluyendo amplificadores).

Guía de operación rápida en español

Conexión básica

La conexión siguiente es la conexión básica para ver o grabar programas de TV.

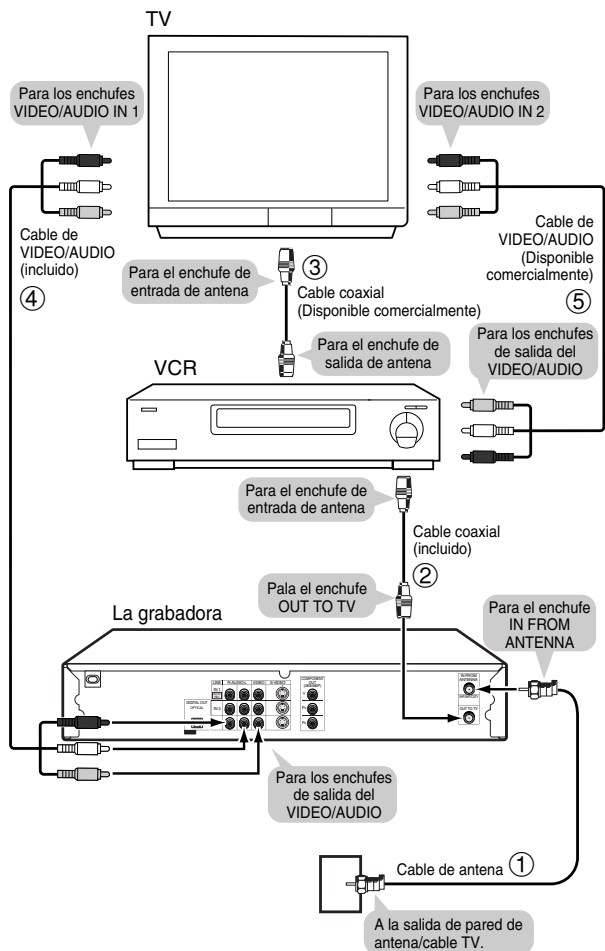

1 Conecte el cable de antena de TV al enchufe **IN FROM ANTENNA** en la parte trasera de esta grabadora.

2 Conecte el enchufe **OUT TO TV** en la parte trasera de esta grabadora, al enchufe de entrada de antena en su VCR usando el cable coaxial.

NOTA

- Si conecta esta grabadora directamente a su TV, omita el paso siguiente.
- La señal de entrada para la toma **IN FROM ANTENNA** pasa completamente hacia el enchufe **OUT TO TV**.

3 Conecte el enchufe de salida de antena en su VCR al enchufe de entrada de antena en su TV, usando el cable coaxial.

4 Conecte los enchufes de salida **VIDEO/AUDIO** en esta grabadora, a los enchufes de entrada **VIDEO/AUDIO** en su TV usando el cable de video/audio.

Asegúrese de que los colores de los enchufes y clavijas coincidan cuando conecta el cable.

5 Conecte los enchufes de salida **VIDEO/AUDIO** en su VCR, a los enchufes de entrada **VIDEO/AUDIO** en su TV usando un cable de audio/video.

Después de la conexión

Conecte los cables de alimentación del TV y VCR. Luego vaya "EZ Set Up".

EZ Set Up

! IMPORTANTE (Precaución durante EZ Set Up):

- No pulse el botón **POWER** de la grabadora ni del control remoto.

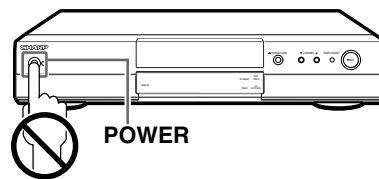

La función de EZ Set Up ajusta automáticamente los canales del sintonizador cuando el cable de la antena está conectado al panel trasero de la grabadora y la clavija del cable de alimentación está conectada a una toma de CA.

1 Asegúrese de que el cable de la antena esté conectado. Para conocer la configuración de la conexión, consulte "Conexión básica".

2 Conecte el enchufe de alimentación de la grabadora a un tomacorriente de CA.

3 Los canales del sintonizador se ajustarán automáticamente.

- Esta grabadora puede controlar y utilizar señales horarias (señales EDS), emitidas por algunos canales de televisión, para poner automáticamente en hora el reloj.

NOTA

- Si la alimentación se suministra a la grabadora antes de que el cable se encuentre conectado, EZ Setup Up no podrá preajustar los canales en la memoria. Si esto llega a suceder, preajuste **RESET** en la parte delantera de la grabadora. La función EZ Set Up volverá a funcionar nuevamente.
- Si se conecta la alimentación durante EZ Set Up, el ajuste automático de los canales se interrumpirá y los canales del sintonizador no podrán ser preajustados.
- La Puesta en Hora Automática del Reloj puede tardar varios minutos.



Guía de operación rápida en español

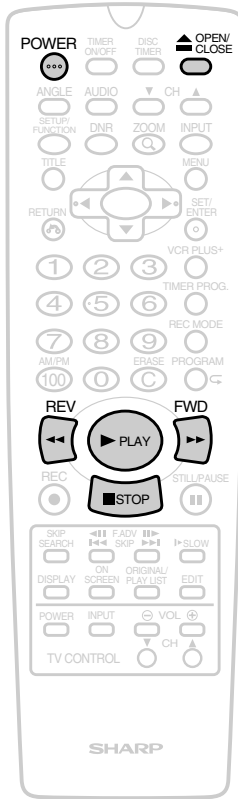

Reproducción de DVD

Reproduce solamente los discos para reproducción

DVD VIDEO

- 1 Encienda el TV y cambie el canal de TV para "VIDEO" externo o canal "AV" que esta conectado a los enchufes de salida de VIDEO/AUDIO.**
- 2 Pulse POWER. La grabadora se enciende.**
- 3 Pulse OPEN/CLOSE para abrir la bandeja de discos.**
- 4 Coloque el disco en la bandeja de discos.**
 - Colóquelo con el lado del título impreso orientado hacia arriba, y alinéelo con las guías.
 - Cuando cargue un disco de dos caras, colóquelo con el lado que Ud. desee reproducir orientado hacia abajo.

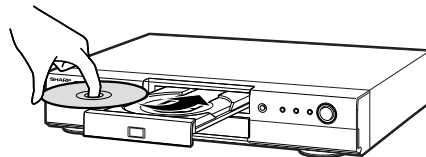

- 5 Pulse OPEN/CLOSE para cerrar la bandeja de discos.**
 - Cuando el disco está siendo identificado (se visualiza "LOAD" en la visualización del panel delantero), el indicador DISC IN sobre el panel delantero destella. El indicador se ilumina cuando el disco termina de ser identificado ("LOAD" desaparece).
 - Algunos discos inician la reproducción automáticamente.
- 6 Pulse ►PLAY para iniciar la reproducción.**
 - Si está reproduciendo un disco DVD-VIDEO, puede aparecer un menú.
- 7 Pulse ■STOP para detener la reproducción.**

Avance rápido/Retroceso rápido

DVD VIDEO DVD RW DVD RW DVD R VIDEO CD
AUDIO CD VR MODE VIDEO MODE

Pulse FWD►► o ◀◀REV durante la reproducción.

- El disco comienza una exploración rápida a una velocidad 2x (1).

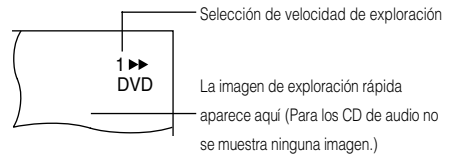

- Para los DVD se disponen de tres velocidades y dos para los CD. Cada vez que se presiona FWD►► o ◀◀REV, la velocidad de exploración rápida cambia en la secuencia siguiente:

(DVD)
→ 1 (alrededor de x2) → 2 (alrededor de x8)
← 3 (alrededor de x32) ←

(CD de video y CD de audio)
→ 1 (alrededor de x2) → 2 (alrededor de x8)

Función de avance rápido/retroceso rápido (búsqueda) sobre la grabadora

Pulse y mantenga SKIP ◀◀ / ►► durante más de 2 segundos sobre la parte delantera de la grabadora.

- La velocidad de búsqueda es 2 (alrededor de x8).

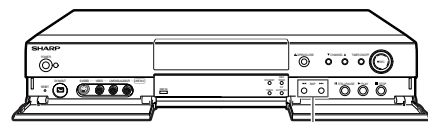

SKIP ◀◀ / ►►

NOTAS

- En algunos casos, la función de exploración rápida se encuentra inhabilitada.
- En algunos discos DVD y CD de video, el audio y subtítulos no son reproducidos durante la reproducción de exploración rápida.
- Con un disco DVD, no puede buscar pasando un título. La reproducción se inicia desde el inicio del título.
- Durante la reproducción con exploración rápida, el sonido puede no generarse.
- Cuando la función de búsqueda en avance rápido es usada durante la reproducción de un disco de video DVD, la velocidad puede diferir de la que se describe en el manual, dependiendo en el disco y en la escena que se está reproduciendo.



Guía de operación rápida en español



Omisión (Avance/Retroceso)

DVD VIDEO DVD RW DVD RW DVD R VIDEO CD
AUDIO CD

Mientras está reproduciendo un disco, esta función salta al inicio del capítulo/pista siguiente (Avance), o al capítulo/pista actual (Retroceso), y automáticamente inicia la reproducción de ese capítulo/pista.

Pulse **SKIP>>>I** o **I<<<SKIP** durante la reproducción.

- La reproducción omite en avance un capítulo/pista por cada vez que se presiona **SKIP>>>I**.
- Si presiona **I<<<SKIP** y se inicia la reproducción, y entonces presiona **I<<<SKIP** nuevamente dentro de los 5 segundos, la reproducción retorna al inicio del capítulo/pista previo.

NOTA

- En algunos discos, las funciones de omisión se encuentran inhabilitadas.

Cámara lenta

DVD VIDEO DVD RW DVD RW DVD R VIDEO CD

1 Pulse **SLOW** durante la reproducción.

- Se disponen de tres velocidades. Cada vez que se presiona **SLOW**, la velocidad de la reproducción en cámara lenta cambia en la secuencia siguiente:

→ 1 (alrededor de $\times 1/2$) → 2 (alrededor de $\times 1/8$)
3 (alrededor de $\times 1/16$) ←

2 Pulse **PLAY** para retornar a la reproducción normal.

NOTA

- En algunos discos, las funciones de reproducción en cámara lenta se encuentran inhabilitadas.

Avance de cuadro Imagen fija/pausa

DVD VIDEO DVD RW DVD RW DVD R VIDEO CD

1 Pulse **STILL/PAUSE** durante la reproducción.

- La reproducción es de imagen fija.
- La reproducción es pausada cuando se reproduce un CD de audio.

2 Pulse **F.ADV** o **IIF.ADV**.

- El disco avanza de un cuadro a la vez cada vez que presiona **F.ADV**.
- El disco retrocede en un cuadro cada vez que presiona **IIF.ADV**.
- Si presiona y mantiene **SKIP>>>I** durante más de 2 segundos en la parte delantera de la grabadora, se inicia la búsqueda.

3 Pulse **PLAY** para retornar a la reproducción normal.

NOTAS

- En algunos discos, las funciones de imagen fija/pausa y avance de cuadro se encuentran inhabilitadas.
- Las funciones de reproducción de avance de cuadro se encuentran inhabilitadas para los CD de audio.
- Las funciones de reproducción de retroceso de cuadro se encuentran inhabilitadas para los CD de video.
- La calidad de imagen puede disminuir durante el avance o retroceso de cuadro, con un disco que no sea un disco de modo DVD-R VR (tal como un disco de video DVD).



Grabación básica

DVD RW | DVD RW | DVD R
VR MODE | VIDEO MODE

1 Encienda el TV y cambie el canal de TV a "VIDEO" externo o canal "AV" conectado a las enchufes de salida de VIDEO/AUDIO.

2 Pulse **POWER**. La grabadora se enciende.

3 Pulse **OPEN/CLOSE** para abrir la bandeja de discos.

4 Coloque el disco en la bandeja de discos.

- Tome del disco sin tocar ninguna de sus superficies, ubicando con el lado del título impreso hacia arriba.

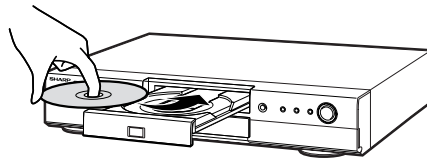

5 Pulse **OPEN/CLOSE** para cerrar la bandeja de discos.

- Cuando el disco está siendo identificado (se visualiza "LOAD" en la visualización del panel delantero), el indicador DISC IN sobre el panel delantero destella. El indicador se ilumina cuando el disco termina de ser identificado ("LOAD" desaparece).
- Si coloca un disco completamente en blanco, la grabadora toma un corto tiempo mientras inicializa el disco (toma alrededor de 60 a 90 segundos).

6 Pulse **CH ▲ / ▼** para seleccionar el canal de TV a grabar.

- Compruebe si el canal está ajustado al canal que desea grabar sobre la pantalla de TV.

7 Pulse **REC MODE** para seleccionar el modo de grabación.

- El modo actual se visualiza sobre la visualización del panel delantero.

- Cada vez que se presiona **REC MODE**, el modo cambia de la manera siguiente:

Modo VR:

→ FINE → SP → LP → EP →

Modo Video:

→ FINE → SP → LP →

8 Pulse **●REC**.

DVD-RW:

La grabación se inicia inmediatamente.

- El indicador de grabación sobre la visualización del panel delantero se ilumina.

DVD-R:

La grabadora se prepara para iniciar la grabación cuando se ajusta "GRAB DVD-R" en "PROG. PARA GRABACIÓN" a "OPR. 2". Presione de nuevo **●REC** para iniciar la grabación.

- La grabación continúa hasta que presiona **■STOP** o el disco se llena.
- Si prefiere una grabación DVD-R para trabajar de la misma manera que la grabación a DVD-RW, ajuste "GRAB DVD-R" en "PROG. PARA GRABACIÓN" a "OPR. 1".



CONSUMER LIMITED WARRANTY

(Valid for warranty service in the U.S. only)

CONSUMER LIMITED WARRANTY

SHARP ELECTRONICS CORPORATION warrants to the first consumer purchaser that this Sharp brand product (the "Product"), when shipped in its original container, will be free from defective workmanship and materials, and agrees that it will, at its option, either repair the defect or replace the defective Product or part thereof with a new or remanufactured equivalent at no charge to the purchaser for parts or labor for the period(s) set forth below.

This warranty does not apply to any appearance items of the Product nor to the additional excluded item(s) set forth below nor to any Product the exterior of which has been damaged or defaced, which has been subjected to improper voltage or other misuse, abnormal service or handling, or which has been altered or modified in design or construction.

In order to enforce the rights under this limited warranty, the purchaser should follow the steps set forth below and provide proof of purchase to the servicer.

The limited warranty described herein is in addition to whatever implied warranties may be granted to purchasers by law. ALL IMPLIED WARRANTIES INCLUDING THE WARRANTIES OF MERCHANTABILITY AND FITNESS FOR USE ARE LIMITED TO THE PERIOD(S) FROM THE DATE OF PURCHASE SET FORTH BELOW. Some states do not allow limitations on how long an implied warranty lasts, so the above limitation may not apply to you.

Neither the sales personnel of the seller nor any other person is authorized to make any warranties other than those described herein, or to extend the duration of any warranties beyond the time period described herein on behalf of Sharp.

The warranties described herein shall be the sole and exclusive warranties granted by Sharp and shall be the sole and exclusive remedy available to the purchaser. Correction of defects, in the manner and for the period of time described herein, shall constitute complete fulfillment of all liabilities and responsibilities of Sharp to the purchaser with respect to the Product, and shall constitute full satisfaction of all claims, whether based on contract, negligence, strict liability or otherwise. In no event shall Sharp be liable, or in any way responsible, for any damages or defects in the Product which were caused by repairs or attempted repairs performed by anyone other than an authorized servicer. Nor shall Sharp be liable or in any way responsible for any incidental or consequential economic or property damage. Some states do not allow the exclusion of incidental or consequential damages, so the above exclusion may not apply to you.

THIS WARRANTY GIVES YOU SPECIFIC LEGAL RIGHTS. YOU MAY ALSO HAVE OTHER RIGHTS WHICH VARY FROM STATE TO STATE.

Model Specific Section

<u>Your Product Model Number & Description:</u>	DV-RW2U DVD RECORDER (Be sure to have this information available when you need service for your Product.)
<u>Warranty Period for this Product:</u>	One (1) year parts and ninety (90) days labor from date of purchase.
<u>Additional Item(s) Excluded from Warranty Coverage (if any):</u>	Non-rechargeable batteries.
<u>Where to Obtain Service:</u>	From a Sharp Authorized Servicer located in the United States. To find the location of the nearest Sharp Authorized Servicer, call Sharp toll free at 1-800-BE-SHARP.
<u>What to do to Obtain Service:</u>	Ship prepaid or carry in your Product to a Sharp Authorized Servicer. Be sure to have Proof of Purchase available. If you ship the Product, be sure it is insured and packaged securely.

TO OBTAIN SUPPLY, ACCESSORY OR PRODUCT INFORMATION, GO TO OUR WEBSITE AT www.sharp-usa.com OR CALL 1-800-BE-SHARP.

SHARP®

SHARP ELECTRONICS CORPORATION

Sharp Plaza, Mahwah, New Jersey 07430-2135

SHARP CORPORATION

Osaka, Japan

Printed in Malaysia
Impreso en Malasia
TINS-A555WJZZ
03P01-MSM